

StorEdge™ Inverter Wiring Guide & On Site Checklist for Europe, APAC, South Africa

This document is a battery wiring guide and contains an on-site checklist with steps for post-installation verification of a StorEdge system for the following batteries:

- LG Chem RESU7H/RESU10H

For more details, please refer to the StorEdge Installation Guide supplied with the StorEdge Inverter. For additional assistance contact SolarEdge Support (see page 8).

Wiring Guide



WARNING!

For LG Chem RESU7H/RESU10H batteries:

Before wiring the system, make sure that the battery is powered off, using both of the following switches:

- * Auxiliary power supply switch
- * Circuit breaker switch

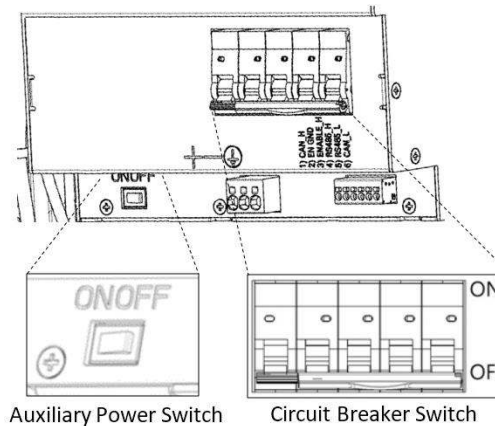

Figure 1: LG Chem Auxiliary Power Switch and Circuit Breaker Switches

Wiring Types and Connectors

To connect the battery to the StorEdge Inverter, use the following wiring types and connectors:

Recommended Cable Type (min-max cross section)	SolarEdge Connector	LG Chem RESU7H/RESU10H Battery Connector
DC: 6 mm ² (2.5-6 mm ²), 600V insulated	BAT DC +	DC +
	BAT DC -	DC -
		Ground
Control and monitoring: 5-wire shielded twisted pair cable, 0.2 mm ² (0.2-1.5 mm ²), 600V insulated. CAT5 600V insulated can also be used.	En (enable)	ENABLE_H
	V+	Not connected
	B- (RS485)	RS485_L
	A+ (RS485)	RS485_H
	G (RS485) or Thermal (depending on inverter type)	EN_G

Wiring Diagrams – Connecting Batteries to the StorEdge Inverter

The diagrams on the following pages illustrate the connection of batteries to the StorEdge system. The following table will help you find the appropriate wiring diagram for your system configuration. Pay attention to whether the battery DIP switch setup on the communication unit main board has 2 or 3 switches.

Battery Type	Connected to	Wiring Diagram
LG Chem RESU7H/RESU10H	StorEdge Inverter with 2 DIP Switches	See Figure 2 on page 3
	StorEdge Inverter with 3 DIP Switches	See Figure 3 on page 3

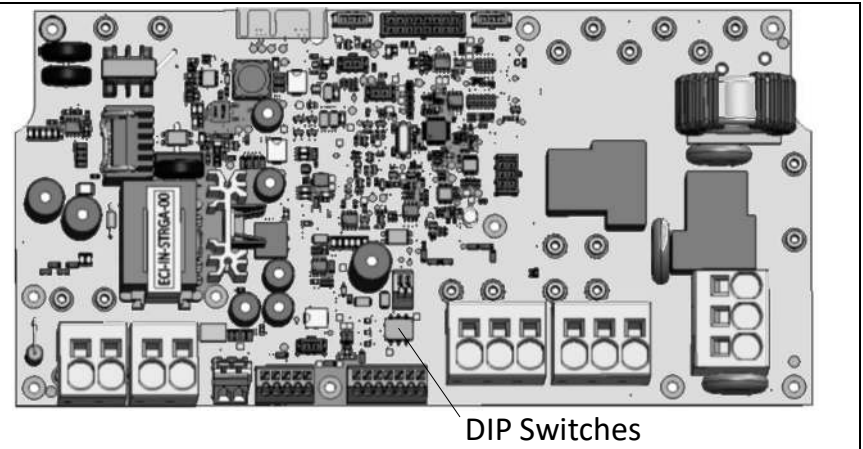

Connecting the LG Chem RESU7H/RESU10H to a StorEdge Inverter with Two DIP Switches and SolarEdge Meter

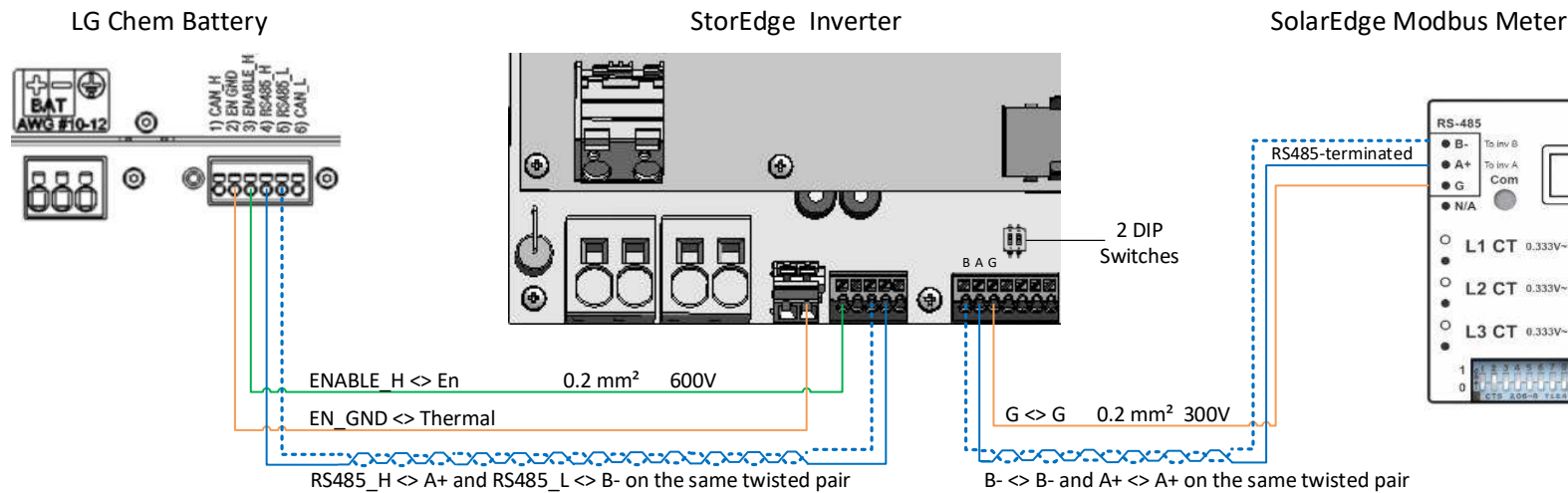

Figure 2: Connecting the LG Chem RESU7H/RESU10H to a StorEdge Inverter with Two DIP Switches and SolarEdge Meter

Connecting the LG Chem RESU7H/RESU10H to a StorEdge Inverter with Three DIP Switches and SolarEdge Meter

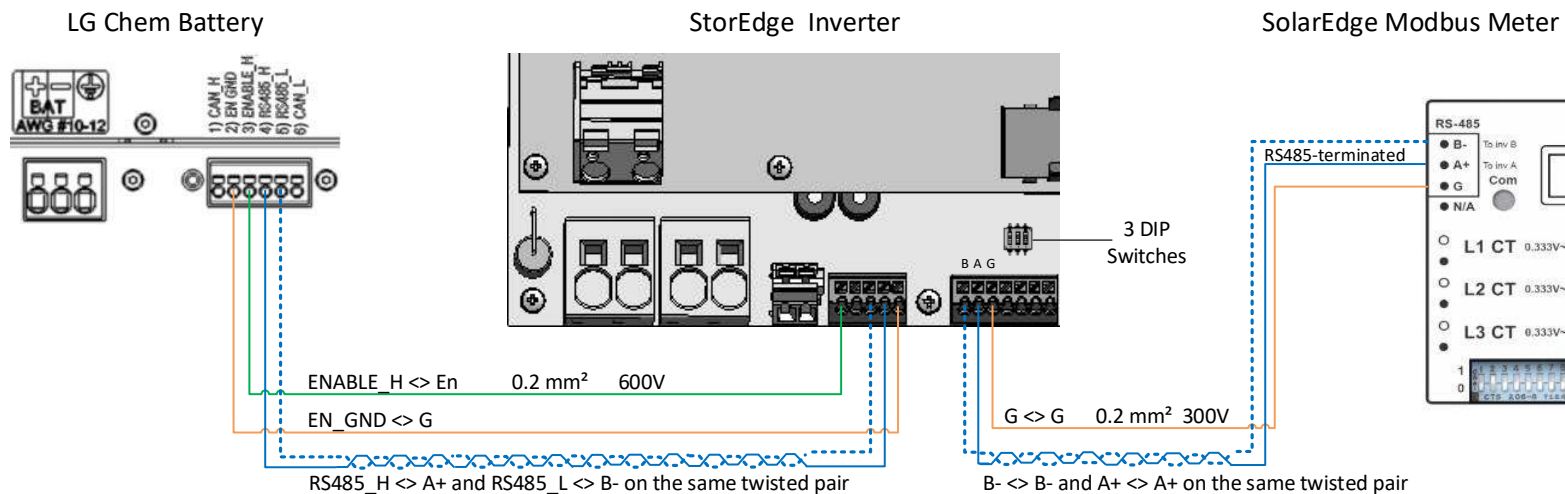
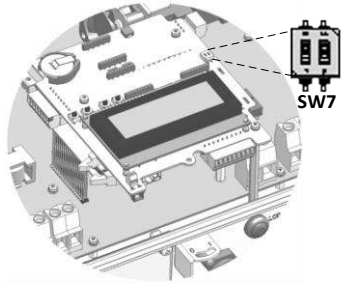

Figure 3: Connecting the LG Chem RESU7H/RESU10H to a StorEdge Inverter with Three DIP Switches and SolarEdge Meter

Switch Settings

Setting the DIP Switches on the Inverter Communication Board



Set DIP switch SW7

RS485-1	RS485-2
For RS485-1 connections, use DIP Switch 1 (leftmost): * ON (up): Terminated (no meter installed) * OFF (down): Not terminated (meter is installed)	For RS485-2 connections, use DIP Switch 2 (rightmost): * ON (up): Terminated (no meter installed) * OFF (down): Not terminated (meter is installed)

Setting the DIP Switches on the Inverter Connection Unit Main Board (with Two or Three DIP Switches)



2 DIP Switches



3 DIP Switches

DIP Switch 1 (leftmost)	DIP Switch 2 (rightmost)	DIP Switch 1 (leftmost)	DIP Switch 2 (center)	DIP Switch 3 (rightmost)
ON (up)	ON (up)	ON (up)	ON (up)	ON (up)



Post Installation Verification and Configuration

Follow the checklist below to verify that the system is properly connected and configured. The checklist is suitable for a backup system with a single StorEdge Inverter, a single battery, and a single SolarEdge Modbus Meter installed at the grid connection point.

For other system configurations, follow the steps in the StorEdge Installation Guide supplied with the StorEdge Inverter.

Step	Verification Action	Checked		
1	Installation and Wiring			
	1.1	Verify the distance between components complies with the distances detailed in the supplied installation guide.	<input type="checkbox"/>	
	1.2	Take a photograph of the battery connection area and send to SolarEdge support (useful for future debugging if necessary).	<input type="checkbox"/>	
	1.3	Take a photograph of the connection area of the StorEdge Inverter and send it to SolarEdge support.	<input type="checkbox"/>	
	1.4	Take a photograph of the installation and send it to SolarEdge support.	<input type="checkbox"/>	
	1.5	Verify that the battery splash cover is closed.	<input type="checkbox"/>	
	1.6	Verify that the backed-up loads panel is wired (relevant for backup systems only).	<input type="checkbox"/>	
	1.7	Verify that the StorEdge Inverter's DIP switches are configured as shown on page 4.	<input type="checkbox"/>	
	1.8	Verify that all DC, communication and AC cabling connections are completed as follows:		
		1.8.1	Check AC wiring and circuit breaker.	<input type="checkbox"/>
		1.8.2	Check string DC input voltage. Expect 1V per optimizer in the string.	<input type="checkbox"/>
		1.8.3	Verify that grounding is properly connected in the battery and inverter.	<input type="checkbox"/>
		1.8.4	Check the DC wiring to the battery, according to the wiring diagram you selected from the table on page 4. Check the connections and verify that all are securely connected.	<input type="checkbox"/>
		1.8.5	Check connections to the battery and the switch setup as described earlier in this document.	<input type="checkbox"/>
1.8.6		Check connections to the meter. If no meter is connected, the inverter's RS485 bus must be terminated using the DIP switches (see page 4).	<input type="checkbox"/>	
1.8.7	Check that a 9V battery is installed in the StorEdge Inverter.	<input type="checkbox"/>		
1.8.8	Check meter AC and CT connections including CT direction: Connect the meter to power supply. Check the LEDs: when configured as export/import meter: green=import, red=export.	<input type="checkbox"/>		
1.8.9	Check connection to the Internet with one of the following options: Ethernet, Wi-Fi, Cellular, ZigBee Module. The connection status displayed should be S_OK.	<input type="checkbox"/>		
2	Commissioning			
	2.1	LG Chem Battery: Switch on Auxiliary power supply and Circuit breaker switch, as shown in Figure 1.	<input type="checkbox"/>	
	2.2	Activate the inverter using the supplied activation card.	<input type="checkbox"/>	
	2.3	Switch on the inverter AC.	<input type="checkbox"/>	
	2.4	Perform pairing when the modules are exposed to sunlight.	<input type="checkbox"/>	

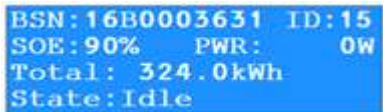
Step	Verification Action	Checked	
3	RS485 Configuration Verification (for one Battery and one Export + Import meter)		
	3.1	If not already OFF, switch OFF the StorEdge Connection Unit switch (for StorEdge inverter).	<input type="checkbox"/>
	3.2	Switch the inverter ON/OFF switch to OFF.	<input type="checkbox"/>
	3.3	Devices	
	3.3.1	Enter Setup mode and select Communication > RS485-1 Conf > Multi Devices	<input type="checkbox"/>
	3.4	Meter	
	3.4.1	Select Communication > RS485-1 > Meter 2 > Meter ID: 2, Device Type <MTR>, Protocol <WN>, CT Rating (as per CT label), Device ID <2>, Meter Function (E+I).	<input type="checkbox"/>
	3.4.2	Verify Device Type > Revenue Meter	<input type="checkbox"/>
	3.4.3	Verify Protocol > Meter	<input type="checkbox"/>
	3.4.4	Verify that the CT value matches the value that appears on the CT label: CT Rating > <xxxxA>.	<input type="checkbox"/>
3.4.5	If CT resets to 0, check the communication with the meter.	<input type="checkbox"/>	
3.5	Battery		
3.5.1	Select Communication > RS485-1 > Battery 1 > Protocol (LG Battery) . Select Communication > RS485-1 > Battery 1 > Battery ID (15) .	<div style="background-color: #007bff; color: white; padding: 5px; border: 1px solid #007bff;"> > Device Type <BAT> Protocol <LG> Device ID <15> Battery Info<Test> </div>	
3.6	Optional: RS485 Expansion Kit		
3.6.1	For a system with multiple inverters that has a single RS485 bus only, install and configure an RS485 Expansion Kit. Refer to the RS485 Expansion Kit Installation Guide. http://www.solaredge.com/files/pdfs/RS485_expansion_kit_installation_guide.pdf	<input type="checkbox"/>	
4	RS485 Connection Verification		
	Press the inverter external LCD light button to display the status screens one after the other until a screen like the following is displayed:		
	4.1	Check the RS485 communication status: <ul style="list-style-type: none"> Verify that the number under Prot displays the number of configured devices. Verify that the number under ## displays the number of communicating devices. 	<div style="background-color: #007bff; color: white; padding: 5px; border: 1px solid #007bff;"> Dev Prot ## RS485 - 1 <MLT><03><03> </div>
4.2	Check the meter(s): In the meter(s) status screen check that the status is OK. If Comm. Error appears, refer to the troubleshooting section in the supplied installation guide.	<div style="background-color: #007bff; color: white; padding: 5px; border: 1px solid #007bff;"> Export Meter Status: OK Power [W]: x.xxxx Energy [Wh]: x.xxxx </div>	

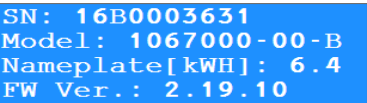
5	Check Battery Connection		
5.1	Scroll through the menus until you reach the battery status screen. Check the battery information: BSN (battery serial number), ID (15 for LG), SOE (battery capacity in percentage), PWR (charge/discharge power), Total (total discharged energy) and the State (Charging/Discharging, Idle, Init or Fault).		<input type="checkbox"/>
6	Inverter + Battery Firmware Upgrade		
6.1	Insert a micro SD card with the latest firmware version available on http://solaredge.com/storedge/firmware .		<input type="checkbox"/>
6.2	Close the inverter cover.		<input type="checkbox"/>
6.3	Switch on the inverter ON/OFF switch.		<input type="checkbox"/>
6.4	Using the external LCD light button enter Setup mode and select Maintenance > SW upgrade > Yes, wait for running script to finish, duration: 30 minutes.		<input type="checkbox"/>
Battery Firmware Version Check			
6.5	Switch OFF the inverter and wait 3 minutes.		<input type="checkbox"/>
6.6	Select Communication > RS485-1 > Battery 1 > Battery Info		<input type="checkbox"/>
7	Setup StorEdge Operating Mode		
7.1	Turn ON the inverter.		<input type="checkbox"/>
7.2	Use the status screens to check charge or discharge according to the current condition.		<input type="checkbox"/>
7.3	Set up the operating mode according to one of the following options:		
	Maximize Self Consumption		
7.3.1	Select Power Control > Energy Manager > Energy Control > Max self-Consume		<input type="checkbox"/>
	Charge/Discharge Profile Programming		
7.3.2	Select Power Control > Energy Manager > Energy Control > Time of Use		<input type="checkbox"/>
	Backup Only		
7.3.3	Select Power Control > Energy Manager > Energy Control > Backup only		<input type="checkbox"/>
7.4	Optional: Set additional StorEdge options		
	AC Charge		
7.4.1	Select Power Control > Energy Manager > Storage Ctrl > AC Charge > Enable		<input type="checkbox"/>
	Backup reserve		
7.4.1	Select Power Control > Energy Manager > Storage Ctrl > Backup Rsvd > {Value}		<input type="checkbox"/>

Support and Contact Information

Australia (+61)	1800 465 567	support@solaredge.net.au	
APAC (Asia Pacific) (+972)	073 2403118	support-asia@solaredge.com	
China (+86)	21 6212 5536	support_china@solaredge.com	
France and Belgium (+33)	0800 917 410	support@solaredge.fr	
DACH and Rest of Europe (+49)	089 454 59730	support@solaredge.de	
Italy (+39)	0422 053700	support@solaredge.it	
Japan (+81)	03 5530 9360	support@solaredge.jp	
Netherlands (+31)	0800 0221 089	support@solaredge.nl	
New Zealand (+64)	0800 144 875	support@solaredge.net.au	
United Kingdom (+44)	0800 028 1183	support-uk@solaredge.com	
US & Canada (+1)	510 498 3200	ussupport@solaredge.com	
Greece (+30)	00800 125574		
Middle East & Africa (+972)	073 2403118		
South Africa (+27)	0800 982 659		support@solaredge.com
Turkey(+972)	073 240 3118		
Worldwide (+972)	073 240 3118		

Before contact, make sure to have the following information at hand:

- Inverter and power optimizer model numbers
- Serial number of the product in question
- The error indicated on the inverter screen or on the SolarEdge monitoring portal, if there is such an indication.
- System configuration information, including the type and number of modules connected and the number and length of strings.
- The communication method to the SolarEdge monitoring portal, if the site is connected
- Inverter software version as appears in the ID status screen.