



Installation and operating instructions

Solar charge controller
Solarix MPPT 1010 and 2010

EN

Contents

1. About these instructions	3
1.1 Applicability	3
1.2 Users	3
1.3. Description of symbols	3
2. Safety	3
2.1 Proper usage.....	3
2.2 Improper usage	3
2.3 General safety instructions	4
2.4 Other risks	4
2.5 Behaviour in the case of faults	4
3. Description	5
3.1 Functions	5
3.2 Structure.....	6
3.3 LED displays	7
4. Installation	7
4.1. Mounting the solar charge controller.....	8
4.2 Connection	8-9-10-11-12
5. Operation	12
6. Options	13
7. Maintenance	13
8. Faults and remedies	13-14-15-16
9. Technical data	17
10. Legal guarantee	18

1. About these instructions

These operating instructions are part of the product.

- ▶ Read these operating instructions carefully before use,
- ▶ keep them over the entire lifetime of the product,
- ▶ and pass them on to any future owner or user of this product.

1.1 Applicability

This manual describes the installation, function, operation and maintenance of the solar charge controller.

Further technical information is provided in a separate technical manual.

1.2 Users

These operating instructions are intended for end customers. A technical expert must be consulted in cases of uncertainty.

1.3. Description of symbols

Safety instructions are identified as follows:



SIGNAL WORD

Type, source and consequences of the danger!

- ▶ Measures for avoiding danger
-

Instructions relating to the functional safety of the system are in **bold type**.

2. Safety

2.1 Proper usage

The solar charge controller may only be used in PV systems for charging and controlling lead-acid batteries with liquid or solid electrolyte in accordance with these operating instructions and the charging specifications of the battery manufacturer.

2.2 Improper usage

No energy source other than a solar generator may be connected to the solar charge controller. No mains devices, diesel generators or wind generators may be connected.

Do not connect any defective or damaged measuring equipment.

2.3 General safety instructions

- ▶ Follow the general and national safety and accident prevention regulations.
- ▶ Never alter or remove the factory plates and identification labels.
- ▶ Keep children away from PV systems.
- ▶ Never open the device.

2.4 Other risks

Danger of fire and explosion

- ▶ Do not use the solar charge controller in dusty environments, in the vicinity of solvents or where inflammable gases and vapours can occur.
- ▶ No open fires, flames or sparks in the vicinity of the batteries.
- ▶ Ensure that the room is adequately ventilated.
- ▶ Check the charging process regularly.
- ▶ Follow the charging instructions of the battery manufacturer.

Battery acid

- ▶ Acid splashes on skin or clothing should be immediately treated with soap suds and rinsed with plenty of water.
- ▶ If acid splashes into the eyes, immediately rinse with plenty of water. Seek medical advice.

2.5 Behaviour in the case of faults

Operating the solar charge controller is dangerous in the following situations:

- The solar charge controller does not appear to function at all.
- The solar charge controller or connected cables are visibly damaged.
- Emission of smoke or fluid penetration.
- When parts are loose.
- ▶ In these cases immediately remove the solar charge controller from the battery and solar module.

3. Description

3.1 Functions

The solar charge controller

- monitors the battery voltage,
- controls the charging process,
- controls the connection/disconnection of loads connected to the load output.

This optimises battery use and significantly extends its service life.

A battery charging algorithm protects the battery from harmful states. Activation of the three deep discharge functions (LVW, LVD and LVR) is dependent upon the battery voltage.

3.1.1 MPP tracking

This solar charge controller meets the latest technological standards since it is equipped with an optimal MPP tracking algorithm and thus can use at all times the maximum available output of the solar module. You will find more detailed documentation about MPP tracking in the technical manual; which can be accessed at www.stecasolar.com.

3.1.2 What is MPP tracking (MPPT)?

MPPT stands for "Maximum Power Point Tracking". This describes a process by means of which the solar module is always operated at the point of maximum possible power. Because the point the maximum power can vary depending on the operating mode and the local conditions, and because it changes in the course of the day, the term "tracking" is used, i.e. the tracking of this point.

3.1.3 When should charge controllers with MPP tracking be used?

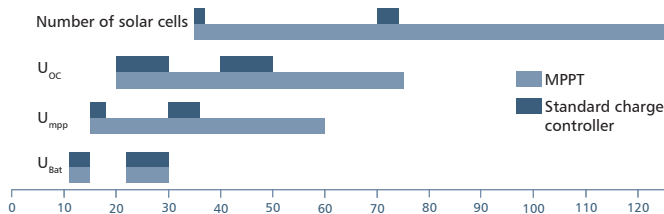

Charge controllers with MPP trackers can be used for a wider range of modules than those without MPPT. With an MPP tracker one is no longer dependent on

the module voltage and string size. The module voltage can deviate significantly from the battery voltage.

3.1.4 Notes on choosing suitable solar modules

This solar charge controller has a maximum input voltage of 100 V. If this is exceeded even for a short time by the connected solar module, the solar charge controller will be damaged beyond repair and can never be used again. This will NOT constitute a guarantee claim, the charge controller must then be replaced at the customer's expense.

The essential value for choosing a solar module is the open circuit voltage (U_{oc}). The open circuit voltage of the solar module is dependent on the ambient temperature. Information on the open circuit voltage of the solar module and on temperature dependence can be found in the data sheet of the solar module. The lower the ambient temperature, the higher the open circuit voltage of the solar module.

The open circuit voltage at -20 C may not exceed the maximum input voltage.

CAUTION

- ▶ If an open circuit voltage of more than 100 V is supplied to the connected solar module, the controller will be **destroyed**. When selecting the solar module, it is important to bear in mind that the open circuit voltage should never exceed 100 V over the entire working temperature range.
- ▶ When using solar modules with a maximum open circuit voltage of between 75 and 100 V (over the entire temperature range), all installation steps must be carried in accordance with protection class II.

3.2 Structure

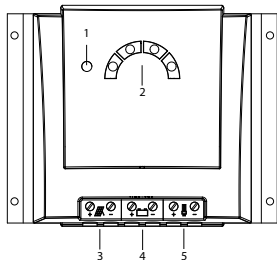

The solar charge controller consists of the following components:

1. Info LED
2. 4 LEDs for displaying the state of charge (red, yellow, green 1 and green 2)
3. Terminal block for connecting the solar module
4. Terminal block for connecting the battery
5. Terminal block for connecting the loads

3.3 LED displays

LED	Status	Meaning
Info LED	illuminates green	normal operation
	flashes red	a fault exists (see "Faults and remedies")
Red LED	flashes quickly	battery empty when the battery continues to be discharged the deep-discharge deactivation is triggered
	flashes	deep-discharge deactivation
Yellow LED	illuminates	battery weak
	flashes	switch-on threshold after deep-discharge deactivation has not yet been reached
1. green LED	illuminates	battery good
2. green LED	illuminates	battery full
	flashes quickly	battery full, charge regulation active, i.e. charging current reduced

4. Installation



WARNING

Danger of explosion from sparking! Danger of electric shock!

Solar modules generate electricity under incident light. The full voltage is present, even when the incident light levels are low.

- ▶ The solar charge controller may only be connected to the local loads and the battery by trained personnel and in accordance with the applicable regulations.
- ▶ Follow the installation and operating instructions for all components of the PV system.
- ▶ Ensure that no cables are damaged.
- ▶ At a voltage of > 75 V, particularly with regard to module open circuit voltage (over the entire temperature range), the entire solar energy system must be installed with protection class II.
- ▶ Protect the solar modules from incident light during installation, e.g. cover them.
- ▶ Never touch uninsulated cable ends.
- ▶ Use only insulated tools.
- ▶ Ensure that all loads to be connected are switched off. If necessary, remove the fuse.
- ▶ Connections must always be made in the sequence described below (see 4.2.2).

4.1. Mounting the solar charge controller

4.1.1 Mounting location requirements

- Do not mount the solar charge controller outdoors or in wet rooms.
- Do not subject the solar charge controller to direct sunshine or other sources of heat.
- Protect the solar charge controller from dirt and moisture.
- Mount upright on the wall (concrete) on a non-flammable substrate.
- Maintain a minimum clearance of 10 cm below and around the device to ensure unhindered air circulation.
- Mount the solar charge controller as close as possible to the batteries (with a safety clearance of at least 30 cm).

4.1.2 Fastening the solar charge controller

- ▶ Mark the position of the solar charge controller fastening holes on the wall.
- ▶ Drill 4 Ø 6 mm holes and insert dowels.
- ▶ Fasten the solar charge controller to the wall with the cable openings facing downwards, using 4 oval head screws M4x40 (DIN 7996).

4.2 Connection

4.2.1 Preparing the wiring

The cross section of the connection cables must be suitable for the currents which occur.

Modulstrom	Batteriestrom	Laststrom	Querschnitt	AWG	Isolation
18 A	20 A	10 A	10 mm ²	8	85°C

The table above applies to the following cable lengths:

- 10 m solar module connection cable
- 2 m battery connection cable
- 5 m load connection cable

Consult a dealer if the specified cable lengths are inadequate.

An additional 30 A external fuse (not provided) must be connected to the battery connection cable, close to the battery pole.

The external fuse prevents dangerous situations due to cable short circuits.

4.2.2 Connection

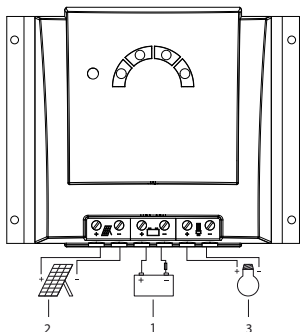

WARNING

Danger of explosion from sparking! Danger of electric shock!

- ▶ At a voltage of > 75 V, particularly with regard to module open circuit voltage (over the entire temperature range), the entire solar energy system must be installed with protection class II.

1st step: connect the battery



CAUTION

- ▶ The device will be destroyed if the battery is connected with the wrong polarity.
- ▶ Label the battery connection cables as a plus cable (A+) and a minus cable (A-).
- ▶ Lay the battery cables in parallel between the solar charge controller and the battery.
- ▶ Connect the battery connection cable with the correct polarity to the middle pair of terminals on the solar charge controller (with the battery symbol).
- ▶ Connect battery connection cable A+ to the positive pole of the battery.
- ▶ Connect battery connection cable A- to the negative pole of the battery.
- ▶ If the connection polarity is correct, the info LED illuminates green.
- ▶ If necessary, remove any external fuse.



2nd step: connect the solar module

CAUTION

- ▶ The connected modules may not exceed an open circuit voltage (VOC) of 100 V, even at extremely low temperatures.
- ▶ Ensure that the solar module is protected from incident light.
- ▶ Ensure that the solar module does not exceed the maximum permissible input current.
- ▶ Label the solar module connection cables as a plus cable (M+) and a minus cable (M-).
- ▶ Lay both solar module connection cables in parallel between the solar module and the solar charge controller.
- ▶ First connect the M+ solar module connection cable to the correct pole of the left pair of terminals on the solar charge controller (with the solar module symbol), then connect the M- cable.
- ▶ Remove the covering from the solar module.



3rd step: connect loads

WARNING

Danger of explosion from sparking! Danger of electric shock!

- ▶ At a voltage of > 75 V, particularly with regard to module open circuit voltage (over the entire temperature range), the entire solar energy system must be installed with protection class II.

Notes

- Connect loads that must not be deactivated by the solar charge controller deep discharge protection, e.g. emergency lights or radio connection, directly to the battery.
- Loads with a higher current consumption than the device output can be directly connected to the battery.

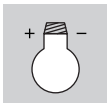

However, the solar charge controller deep discharge protection will no longer intervene. Loads connected in this manner must also be separately fused. Loads of this type can also be reliably connected via an additional output relay (e.g. Steca PA EV 200 A).

- ▶ Label the load connection cables as a plus cable (L+) and a minus cable (L-).
- ▶ Lay the load connection cables in parallel between the solar charge controller and the load.

- ▶ First connect the L+ load cable to the correct pole of the right pair of terminals on the solar charge controller (with the lamp symbol), then connect the L- cable.
- ▶ Replace the load fuse or switch on the load.

4th step: final work

- ▶ Fasten all cables with strain relief in the direct vicinity of the solar charge controller (clearance of approx. 10 cm).

4.2.3 Grounding

Grounding of the controller and connected components in stand-alone systems is not necessary, not standard practice or may be prohibited by national regulations (e.g.: DIN 57100 Part 410: Prohibition of grounding protective low voltage circuits). The following grounding possibilities are available if required:

- Positive grounding: One or more of the negative controller terminals can be grounded.
- Positive grounding: Only *one* of the positive controller terminals may be grounded.

CAUTION

- ▶ Simultaneous grounding of multiple positive controller terminals will result in malfunctions or damage to the charge controller.

Consult the technical manual for more information.

positive grounding:

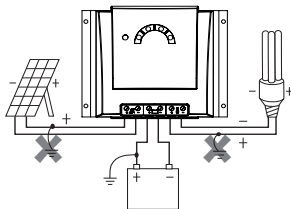

negative grounding:

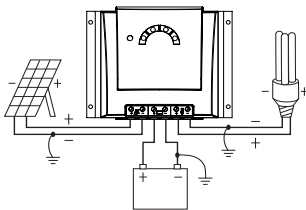



CAUTION

- ▶ Risk of damage to the controller:
Make sure that no common connection for the terminals module plus, battery plus and load plus is available such as a common positive ground connection.
-

4.2.4 Lightning protection

In systems subjected to an increased risk of overvoltage damage, we recommend installing additional lightning protection / overvoltage protection to reduce dropouts. Consult the technical manual for more detailed information.

5. Operation

The solar charge controller immediately begins operation once the battery is connected or the external fuse is inserted.

The display of the solar charge controller shows the current operating mode. User intervention or user settings are not required.

Protection functions

The following integrated protection functions of the solar charge controller ensure that the battery is handled as gently as possible.

The following protection functions are part of the basic function of the controller:

- overcharge protection
- deep discharge protection
- battery undervoltage protection
- solar module reverse current protection

The following installation faults do not destroy the controller. After correcting the fault, the device will continue to operate correctly:

- protection from solar module short circuits / incorrect solar module polarity
- protection from short circuits at the load output or excessive load current
- protection from solar module overcurrent
- protection from device overtemperature
- protection from overvoltage at the load output
- protection from the wrong connection sequence

6. Options

- To change (parameterize) the function values you need the remote control "Steca PA RC100".
- Night light function works or on the remote control "Steca PA RC100" adjustable
- External temperature sensor available (Steca PA TSA10)

7. Maintenance

The solar charge controller is maintenance-free. All components of the PV system must be checked at least annually, according to the specifications of the respective manufacturers.

- ▶ Ensure adequate ventilation of the cooling element.
- ▶ Check the cable strain relief.
- ▶ Check that all cable connections are secure.
- ▶ Tighten screws if necessary.
- ▶ Terminal corrosion

8. Faults and remedies

Fault	Cause	Remedy
No display	• Battery voltage too low	▶ Pre-charge the battery
	• The external fuse in the battery connection cable has blown.	▶ Replace the external fuse
	• Battery is not connected	1. Unclamp all connections 2. Connect a (new) battery with the correct polarity 3. Reconnect the solar module and loads
	• Battery is defective	
• Battery is connected with the wrong polarity	Device may be defective; Return device to specialist dealer	
Info LED flashes red	• Charging interrupted due to excessive charging current	Charging automatically continues as soon as the charging current lies within the permissible range
	• Optobus transfer faulty	Repeat programming
	• Battery voltage too low	Pre-charge the battery
	• Battery voltage too high	Check installation

Fault	Cause	Remedy
Load cannot be operated or only for a short time + info LED flashes red	<ul style="list-style-type: none"> • Load output is switched off due to excessive load current 	<ul style="list-style-type: none"> ▶ Reduce load current, if necessary switch off or disconnect loads ▶ Check loads
	<ul style="list-style-type: none"> • Load output is switched off due to short circuit at load output 	<ol style="list-style-type: none"> 1. Disconnect loads 2. Correct the cause of the short circuit 3. Reconnect loads
	<ul style="list-style-type: none"> • Load output is switched off due to overheating of the solar charge controller 	The load output automatically switches on again once the solar charge controller has cooled down <ul style="list-style-type: none"> ▶ Improve the cooling air circulation ▶ Remove any other heat sources ▶ Check the conditions of use and the mounting location
Load cannot be operated + info LED flashes red + red battery LED flashes	<ul style="list-style-type: none"> • Load output is switched off due to too low battery voltage 	The load output automatically switched on again as soon as the battery voltage lies within the permissible range <ul style="list-style-type: none"> ▶ Pre-charge the battery ▶ Equip loads directly connected to the battery with deep discharge protection ▶ Check the battery and replace if necessary

Fault	Cause	Remedy
Load cannot be operated + info LED flashes red + 2. green LED flashes	• Load output is switched off due to excessive battery voltage	The load output automatically switched on again as soon as the battery voltage lies within the permissible range
	• External charging source is not voltage-limited	<ul style="list-style-type: none"> ▶ Check the external charging source ▶ If necessary, switch off external charging sources ▶ Charge Controller reset: Disconnect the load, disconnect the module and disconnect the battery. Then in reverse order Clamp (battery -> Module -> and finally the load)
Load cannot be operated + info LED illuminates green	• Defective load or installation error	▶ Connect load correctly
		▶ Replace load
Battery is not charged	• Solar module not connected	▶ Connect the solar module
	• Solar module connected with incorrect polarity	▶ Connect the solar module with the correct polarity
	• Short circuit at solar module input	▶ Correct the cause of the short circuit
	• Incorrect solar module voltage	▶ Use a solar module of the specified voltage
	• Device overheated	▶ Make sure the device is well ventilated
	• Solar module defective	▶ Replace the solar module
Battery display jumps quickly	• Large pulse current	▶ Tune the current consumption to match the battery capacity
	• Battery is defective	▶ Replace the battery

Efficiency example:

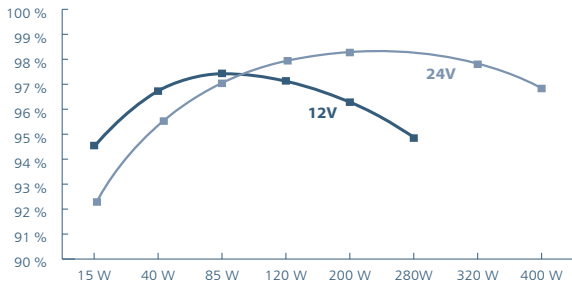

9. Technical data

	MPPT 1010	MPPT 2010
Characterisation of the operating behaviour		
System voltage	12 V (24 V)	
Rated output	125 W (250 W)	250 W (500 W)
Max. efficiency	> 98 %	
Own consumption	10 mA	
DC input side		
MPP voltage	15 V (30 V) < $U_{\text{module}} < 75 \text{ V}$	15 V (30 V) < $U_{\text{module}} < 100 \text{ V}$
Open circuit voltage solar module (at minimum operating temperature)	17 V ... 75 V (34 V ... 75 V)	17 V ... 100 V** (34 V .. 100 V)**
Module current	9 A	18 A
DC output side		
Charging current	10 A	20 A
Load current	10 A	
End-of-charge voltage*	13.9 V (27.8 V)*	
Boost charge voltage*	14.4 V (28.8 V)*	
Equalisation charging*	14.7 V (29.4 V)*	
Reset voltage* (SOC / LVR)	> 50 % / 12.5 V (25.0 V)*	
Deep discharge protection* (SOC / LVD)	< 30 % / 11.5 V (23.0 V)*	
Application conditions		
Ambient temperature	-25 °C ... +40 °C	
Equipment and design		
Terminal clamps (fine-wire / single wire)	16 mm ² / 25 mm ² - AWG 6 / 4	
Degree of protection	IP 32	
Dimensions (X x Y x Z)	187 x 153 x 68 mm	
Weight	approx. 900 g	

* see the chapter "Options" page 13

Technical data at 25 °C / 77 °F

** CAUTION

- ▶ If an open circuit voltage of more than 100 V is supplied to the connected solar module, the controller will be **destroyed**. When selecting the solar module, it is important to bear in mind that the open circuit voltage should never exceed 100 V over the entire working temperature range.
- ▶ When using solar modules with a maximum open circuit voltage of between 75 and 100 V (over the entire temperature range), all installation steps must be carried in accordance with protection class II.

NOTE:

Technical data that varies from the above is given on a device label. Subject to change without notice.

10. Legal guarantee

In accordance with German statutory regulations, there is a 2-year legal guarantee on this product for the customer.

The manufacturer warrants to the specialized trade a voluntary warranty of 5 years from the invoice or receipt date. The manufacturer's warranty applies to products purchased and in operation in an EU country or Switzerland.

The seller will remove all manufacturing and material faults that occur in the product during the legal guarantee period and affect the correct functioning of the product. Natural wear and tear does not constitute a malfunction. No legal guarantee can be offered if the fault can be attributed to third parties, unprofessional installation or commissioning, incorrect or negligent handling, improper transport, excessive loading, use of improper equipment, faulty construction work, unsuitable construction location or improper operation or use. Legal guarantee claims shall only be accepted if notification of the fault is provided immediately after it is discovered. Guarantee claims are to be directed to the seller.

The seller must be informed before guarantee claims are processed. For processing a guarantee claim an exact fault description and the invoice / delivery note must be provided.

The seller can choose to fulfil the legal guarantee either by repair or replacement. If the product can neither be repaired nor replaced, or if this does not occur within a suitable period in spite of the specification of an extension period in writing by the customer, the reduction in value caused by the fault shall be replaced, or, if this is not sufficient taking the interests of the end customer into consideration, the contract is cancelled.

Any further claims against the seller based on this legal guarantee obligation, in particular claims for damages due to lost profit, loss-of-use or indirect damages are excluded, unless liability is obligatory by law.



730927