



Installation and operating instructions

PA Link1 parallel switch box

Index

Introduction	3
1 About these instructions	4
1.1 Applicability.....	4
1.2 Users.....	4
1.3 Description of symbols.....	5
1.4 Scope of delivery.....	5
2 Safety	6
2.1 Proper usage.....	6
2.2 Other risks	6
2.3 Behaviour in the case of faults.....	6
2.4 Exclusion of liability	6
3 Description of the connections	7
4 Installation	7
4.1 Mounting.....	8
4.2 Connection	9
4.3 Function test.....	10
4.4 Making changes to the system	11
5 Operation	11
5.1 Rotary switch settings.....	11
6 Care, maintenance and service.....	12
7 Technical data	12
8 Fault diagnosis and troubleshooting	13
9 Commercial and legal guarantee conditions	13
10 Contact	14

Introduction

Up to 4 Steca Solarix PI 500-12 (-60/-L60) / PI 550-24 (-60/-L60) / PI 1100-24 (-60/-L60) / PI 1500-48 (-60/-L60) stand-alone inverters can be operated in parallel with the PA Link1 parallel switch box on 115 V or 230 V (see table below). One stand-alone inverter works as a master, the others as slaves. The PA Link1 has one output for AC consumers (AC OUT).

Example of a possible application:

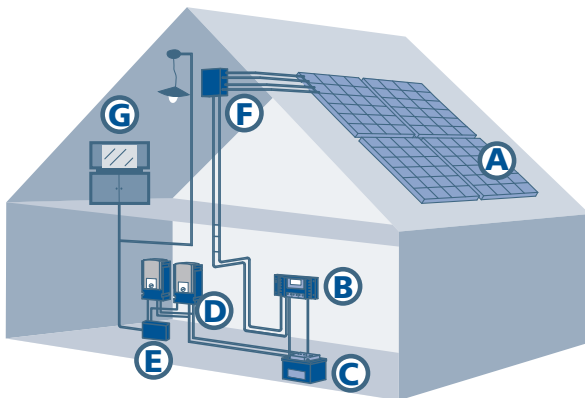

Legend:

- A Solar module
- B Solar charge controller
- C Battery
- D Steca Solarix PI sine wave inverter
- E Steca PA Link1 parallel switch box
- F Generator junction box
- G Electrical load (230 V AC or 115 V AC)

Permissible configurations:

ATTENTION

Risk of malfunction and damage to system components.

- ▶ Only operate stand-alone inverters of the same type and variant together.

Master	Slave	Continuous AC output
12 V DC input voltage		
PI 500-12	-	450 VA
	1 x PI 500-12	900 VA
	2 x PI 500-12	1350 VA
	3 x PI 500-12	1800 VA
24 V DC input voltage		
PI 550-24	-	450 VA
	1 x PI 550-24	900 VA
	2 x PI 550-24	1350 VA
	3 x PI 550-24	1800 VA
PI 1100-24	-	900 VA
	1 x PI 1100-24	1800 VA
	2 x PI 1100-24	2700 VA
	3 x PI 1100-24	3600 VA
48 V DC input voltage		
PI 1500-48	-	900 VA
	1 x PI 1500-48	1800 VA
	2 x PI 1500-48	2700 VA
	3 x PI 1500-48	3600 VA

The table also applies to the "-60" and "-L60" variants.

1 About these instructions

These operating instructions are part of the product.

- ▶ Read these operating instructions carefully prior to installation and use,
- ▶ keep them near the product during its entire service life,
- ▶ and pass them on to any future owner or user of this product.

1.1 Applicability

These instructions describe the installation, function, operation and maintenance of the PA Link1 parallel switch box.

Further information on operating the battery system is contained in the Steca Solarix PI operating instructions.

1.2 Users

These operating instructions are intended for end customers and installers. A technical expert must be consulted in cases of uncertainty.

Installation, putting into operation, maintenance, and removal of the PA Link1 shall only be done by trained qualified personnel observing the applicable on-site installation regulations.

1.3 Description of symbols



1.3.1 The structure of the warning notices

SIGNAL WORD

Type, source and consequences of the danger!

- ▶ Measures for avoiding danger

1.3.2 Danger levels in warning notices

Danger levels	Probability of occurrence	Consequences of non-compliance
 DANGER	Imminent threat of danger	Death, serious bodily injury
 WARNING	Possible threat of danger	Death, serious bodily injury
 CAUTION	Possible threat of danger	Minor bodily injury
ATTENTION	Possible threat of danger	Property damage

1.3.3 Notes

NOTES

Note on easier and safer working habits.

- ▶ Measures for easier and safer working habits

1.3.4 Other symbols and markings in this manual

Symbol	Meaning
▶	Call to action
▷	Result of action
-	Action description
•	List
Emphasis on issue at hand	Emphasis on issue at hand

1.4 Scope of delivery

- ▶ 1 PA Link1
- ▶ 1 RJ45 cable, red, 0.5 m for Master Solarix PI
- ▶ 1 RJ45 cable, grey, 0.5 m for Solarix PI Slave 1
- ▶ 2 RJ45 cables, grey, 1.0 m for Solarix PI Slave 2 to 3
- ▶ 1 installation kit with strain relief clamps and screws
- ▶ 1 issue of installation and operating instructions

2 Safety

2.1 Proper usage

The PA Link1 parallel switch box is exclusively intended for use in stationary autonomous power supplies in accordance with these operating instructions.

The PA Link1 shall only be operated in a permanently installed and closed condition.

Only specialists are permitted to carry out the installation.

Any other use is regarded as improper use of the device. Examples of improper use:

- The PA Link1 parallel switch box must never be connected to the public mains grid or a generator.
- It is not permitted to operate the PA Link1 parallel switch box without fitted cover of the terminals, without casing, or with a damaged casing.
- The device may not be installed outdoors.
- An autonomous power supply system (including PA Link1 parallel switch box) must not be installed, operated or maintained in locations where inflammable gases and vapours can occur, in dusty environments, or in the vicinity of solvents (danger of fire and explosion: ensure that the room is adequately ventilated).
- The PA Link1 parallel switch box, inverters and batteries must not be used in the vicinity of open fires, flames or sparks.

2.2 Other risks



WARNING

Battery acid!

- ▶ Acid splashes on skin or clothing should be immediately treated with soap suds and rinsed with plenty of water.
- ▶ If acid splashes into the eyes, immediately rinse with plenty of water and seek medical advice.

2.3 Behaviour in the case of faults



DANGER

- **The connected inverters do not appear to function.**
- **Parallel switch box, inverter, alternating current cable or battery cable are visibly damaged.**
- **If there is smoke emission or fluid penetration.**
- **If parts are loose!**
- ▶ In these cases immediately disconnect the inverter from the battery and the parallel switch box from the loads.

2.4 Exclusion of liability

The manufacturer can neither monitor compliance with this manual nor the conditions and methods during the installation, operation, usage and maintenance of the parallel switch box. Improper installation of the system may result in damage to property and, as a consequence, bodily injury.

Therefore, we assume no responsibility or liability for loss, damage or costs which result from, or are in any way related to, incorrect installation, improper operation, or incorrect use and maintenance.

Similarly, the manufacturer assumes no responsibility for patent right or other right infringements of third parties caused by usage of this parallel switch box.

The manufacturer reserves the right to make changes to the product, technical data or assembly and operating instructions without prior notice.

- ▶ As soon as it is evident that safe operation is no longer possible (e.g. visible damage), immediately disconnect the inverter from the battery and the parallel switch box from the loads.

3 Description of the connections

- ① Input terminals L Solarix PI slave 1 - 3
- ② Input terminal L Solarix PI master
- ③ Input terminals N Solarix PI slave 1 - 3
- ④ Input terminal N Solarix PI master
- ⑤ Output terminals AC OUT consumer
- ⑥ Data input Solarix PI master, RJ45
- ⑦ Data input Solarix PI slave 1 - 3, 3 RJ45
- ⑧ Cable output AC OUT consumer
- ⑨ Cable input Solarix PI AC master
- ⑩ Cable input Solarix PI AC slave 1 - 3

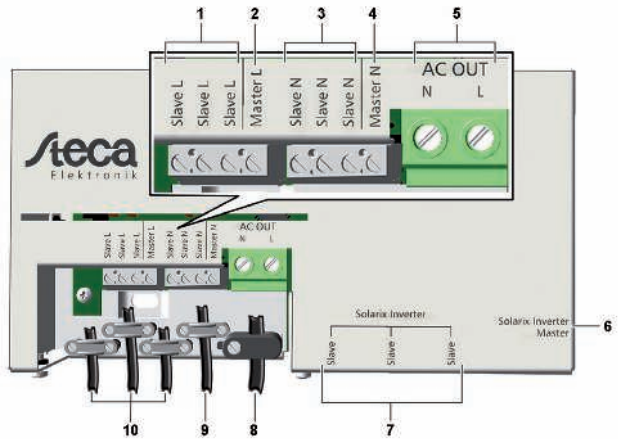

4 Installation

Example layout of a complete system. Representation is schematic.

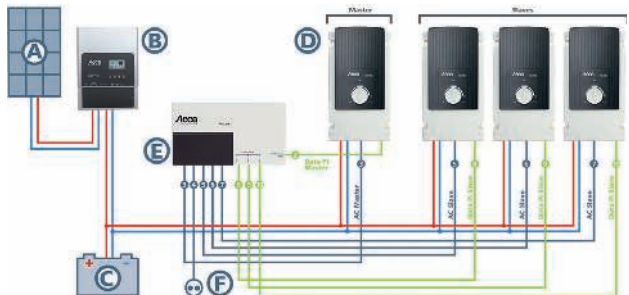

- A Solar module
- B Solar charge controller
- C Battery
- D Sine wave inverter Steca Solarix PI
- E Steca PA Link1 parallel switch box
- F Electric load (230 V AC or 115 V AC)

4.1 Mounting

4.1.1 Mounting location

- ▶ Ensure that the mounting location satisfies the following requirements:
 - Mount in a dry, dust-free indoor room.
 - Mount on non-flammable substrate on the wall (concrete) with cable outlet at the bottom.
 - The mounting location must be protected from unauthorized access, especially by small children.
 - Minimum clearance of approx. 10 cm above and below to allow free air circulation.
 - Enough clearance for the type plate to be visible on the installed device.

4.1.2 Mounting the PA Link1 parallel switch box

- ▶ Unscrew 2 screws (1) on the cover (2) of the terminals.
- ▶ Lift the cover upwards.

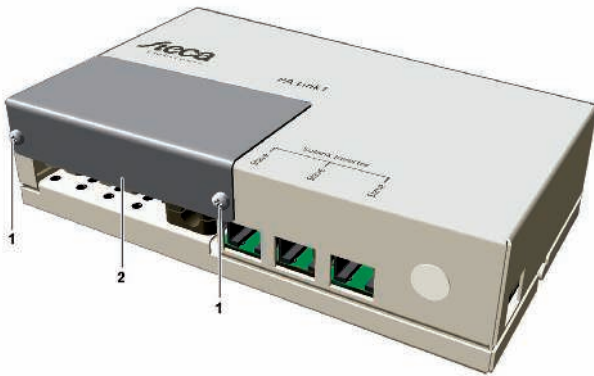

- ▶ Mark 4 bores according to the dimensional drawing and drill with \varnothing 6 mm.

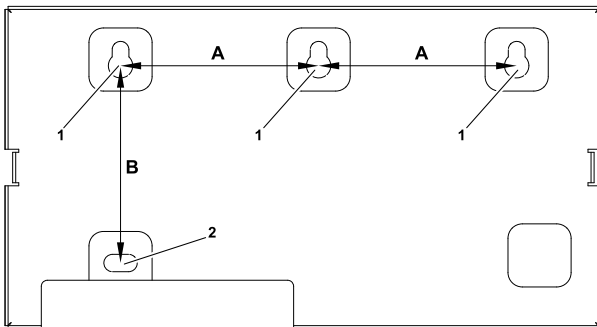

A 65 mm
B 70 mm

- ▶ Insert dowels and screw M5 screws into the three top bores (1). The screw heads must be at a sufficient distance to be able to hang the casing.
- ▶ Hang the casing on the three screws.
- ▶ Screw and tighten one M5 screw through the casing bore (2).

4.2 Connection



WARNING

Danger of explosion from sparking! Danger of electric shock!

- ▶ The parallel switch box may only be connected to the local consumer devices and the inverters by trained personnel and in accordance with the applicable regulations.
- ▶ Connections must always be made in the sequence described below.
- ▶ The cables pre-fitted to the inverter may not be extended and must not be damaged.
- ▶ Only touch-proof voltages (according to SELV/DVC A or appropriate guidelines) may be used at the RJ45 connections.
- ▶ Use only the intended cables and connections.

4.2.1 Connecting the consumers

NOTE

The terminals and data connections are pictured in detail in the figure on page 20.

- ▶ Strip approx. 10 mm of both wire ends of the consumer cable.
- ▶ Introduce the consumer cable through the right-hand strain relief.
- ▶ Connect the consumer cable to a distribution board with a circuit breaker according to the applicable regulations, at the L and N terminals of the AC OUT consumer output. Tightening torque: 1.2 Nm to 1.5 Nm.

Or

- ▶ Install alternating current socket at the terminals of the AC OUT consumer output according to the country-specific regulations.

In the event that, due to local regulations or the AC consumers, grounding is required:

- ▶ Carry grounding out following the adjacent diagram (if TN net is permitted).
- ▶ Tighten the screw of the right-hand strain relief.

4.2.2 Connecting the Solarix PI master and slaves

ATTENTION

Risk of destruction of the device.

- ▶ Never short-circuit the outputs of the stand-alone inverters Solarix PI or the PA Link1.
- ▶ Never connect other devices to the RJ45 connections (Master, Slave). Use the connections exclusively for the PI communication.

- ▶ Insert cable of the stand-alone inverter Solarix PI master from the right into the bottom part of the second strain relief.
- ▶ Depending on the number of slaves, insert the cables of further stand-alone inverters Solarix PI into the bottom parts of the still free strain reliefs.
- ▶ Place clamp clips of the strain reliefs onto the bottom parts and loosely fasten each one with two screws.

ATTENTION

The stand-alone inverters may be damaged in case of incorrect connection.

- ▶ Make sure that all blue cables are connected to N and all brown cables are connected to L.
- ▶ Strip approx. 8 mm of all wire ends.
- ▶ Connect the wires in the parallel switch box in accordance with the terminals' labels (see chapter 3 "Description of the connections"). Tightening torque: 0.5 Nm.
 - Blue: N terminals
 - Brown: L terminals

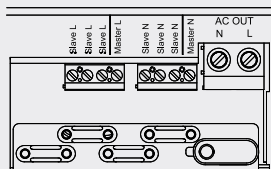

AC OUT

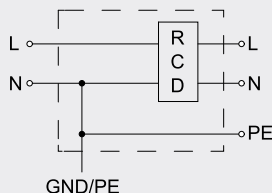

- ▶ Tighten the screws of all strain reliefs.
- ▶ Insert the cover of the terminals from the top into the casing's slot, swivel downwards and fasten with two screws.

4.2.3 Connecting the data lines to Solarix PI stand-alone inverters

- ▶ Plug the red data cable's RJ45 plug of the Solarix PI master into the "Solarix Inverter Master" socket.
- ▶ Plug the grey data cables' RJ45 plugs of the Solarix PI slaves into the "Solarix Inverter Slave" sockets.

NOTE

- ▶ Check that the locking mechanisms of the RJ45 plugs are engaged.
-

4.2.4 Connecting the inverter to the battery



WARNING

Danger of explosion from sparking! Danger of electric shock!

- ▶ Before connecting the inverters, make sure that no load is switched on and all the inverter rotary switches are set at "Off".
- ▶ The cables pre-fitted to the inverters must not be extended.
 - ▶ Switch all the inverter rotary switches to the "Off" setting
 - ▶ Connect the inverters to the battery in accordance with the Steca Solarix PI operating instructions.

The installation of the system is now complete.

4.3 Function test

- ▶ Turn rotary switches on all inverters to "Off".
- ▶ Turn rotary switch on master to "All on".
 - ▷ *The system is working correctly when the LEDs on all inverters light up or blink green.*
 - ▷ *If the LED of an inverter does not light up or blink green, proceed as described in the section "Fault diagnosis and troubleshooting".*
- ▶ To end the function test, switch the master rotary switch to the "Off" setting.

4.4 Making changes to the system

Master and slave(s) are identical inverters. Their function in the system is determined by the connection to the parallel box:

Master: "Solarix Inverter Master" data input and "Master L/N" voltage input
 Slave(s): "Solarix Inverter Slave" data input and "Slave L/N" voltage input



WARNING

Danger of explosion from sparking! Danger of electric shock!

Plugs and cables must not be disconnected when voltage is present!

- ▶ Before pulling out plugs or disconnecting cables make sure that no loads are connected and the inverters are disconnected from the battery.
- ▶ The cables pre-fitted to the inverters must not be extended.

4.4.1 Replacing inverters

Proceed as follows when replacing the master or a slave:

- ▶ Make sure that no loads are connected and the inverters are disconnected from the battery.
- ▶ Pull out the RJ45 plug at the relevant data input.
- ▶ Open the cover on the parallel switch box.
- ▶ Disconnect the input of the relevant master or slave at the parallel switch box.
- ▶ Connect the new master or slave, as described in Section 4.2.

4.4.2 Using a slave as the master

If the master fails, a slave can be used as the new master.

- ▶ Make sure that no loads are connected and the inverters are disconnected from the battery.
- ▶ Pull off RJ45 plugs of all data inputs.
- ▶ Open the cover on the parallel switch box.
- ▶ Disconnect all the cables at the parallel switch box.
- ▶ Connect the reconfigured system as described in Section 4.2.

5 Operation

In parallel operation the power supply is regulated by the rotary switch on the master, see the Steca Solarix PI operating instructions.

The rotary switches at the slaves do not have any function. However, they must be in the "Off" position because otherwise the slaves may eventually become operational unintentionally.

5.1 Rotary switch settings

Master	Slave(s)	Inverter state
Off	Off	Master and slaves switched off
Standby	Off	Load-dependent response of master and slaves, where applicable
On	Off	Master always switched on, slaves switched on as required
All On	Off	Master and slaves always switched on This setting is recommended for high performance devices (at the performance limit), e.g. for operating a washing machine

6 Care, maintenance and service

The device is maintenance-free. If functional faults occur, please consult your dealer and present the payment receipt/invoice.

- ▶ Before cleaning, switch off all loads and switch off the master via the rotary switch (setting "Off").
- ▶ Clean casing surface periodically using a slightly moistened cloth. Do not use solvents.

7 Technical data

PA Link1 parallel switch box	
Operating temperature	0 °C ... +50 °C, under continuous load
Storage temperature	-20 °C ... +70 °C
Humidity	0 % ... 95 % relative humidity, non-condensing
Maximum altitude	2000 m above sea level
Degree of protection	IP 20, use in dry environment
Dimensions (W x H x D)	196 mm x 106 mm x 52 mm
Weight	0.8 kg
Connectable devices	Maximum of 4 stand-alone inverters of the same type and variant: <ul style="list-style-type: none"> • Solarix PI 500-12 (-60/-L60) • Solarix PI 550-24 (-60/-L60) • Solarix PI 1100-24 (-60/-L60) • Solarix PI 1500-48 (-60/-L60) Continuous output at AC OUT consumer output, see table on page 17
Connections	<ul style="list-style-type: none"> • 4 data inputs RJ45 for Solarix PI • 4 230 V AC or 115 V AC¹⁾ voltage inputs for Solarix PI • 230 V AC or 115 V AC¹⁾ consumer output
Connection data, AC OUT terminals	
Conductor cross-section, rigid/flexible	Minimum of 0.5 mm ² to maximum of 16 mm ²
Conductor cross-section, AWG	Minimum of AWG 20 to maximum of AWG 6
Connection data, master/slave terminals	
Conductor cross-section, solid (rigid)	Maximum of 4.0 mm ²
Conductor cross-section, stranded (flexible)	Maximum of 2.5 mm ²
Conductor cross-section, stranded (with ferule)	Maximum of 2.5 mm ²

¹⁾ The voltage corresponds to the output voltage of the stand-alone inverters.

8 Fault diagnosis and troubleshooting

Fault diagnosis and troubleshooting of the individual inverter is described in the Steca Solarix PI operating instructions.

Fault	Cause	Remedy
LED on slave does not light up	<ul style="list-style-type: none"> • Data cable not inserted properly • Data cable defective • Slave defective 	<p>Attention Danger of damage to the inverter.</p> <ul style="list-style-type: none"> ▶ Disconnect the battery and the power cable from the slave before working on the data cable. Then reconnect battery cable. ▶ Connect the power cable only after completion of all work. <hr/> <ul style="list-style-type: none"> ▶ Ensure that the data cable is inserted properly. ▶ If LED does not light up, replace the data cable. ▶ If LED does not light up, replace the slave.
LED on master does not light up	<ul style="list-style-type: none"> • Master defective 	<ul style="list-style-type: none"> ▶ Replace master, e.g. rewire system with a previous slave as master
The system does not work, although the master and slave(s) are in working order	<ul style="list-style-type: none"> • Parallel switch box defective 	<ul style="list-style-type: none"> ▶ Replace parallel switch box
LEDs on inverters signal a malfunction	<ul style="list-style-type: none"> • Wiring fault 	<ul style="list-style-type: none"> ▶ Check the wiring

9 Commercial and legal guarantee conditions

Find the warranty terms on internet at:
www.steca.com/pv-off-grid/warranties

10 Contact

Any further claims against the seller based on this legal guarantee obligation, in particular claims for damages due to lost profit, loss-of-use or indirect damages are excluded, unless liability is obligatory by law. They will help you with all issues you may have.

Steca Elektronik GmbH
Mammostrasse 1
87700 Memmingen
Germany

Fon +49 8331 8558 833
Fax +49 8331 8558 132
E-Mail service@stecasolar.com
Internet www.steca.com

PA Link1 parallel switch box

Type

Series number

Dealer

Company

Contact person

Street

Postcode

Town

Telephone number

Email

Comments

.....
.....
.....
.....
.....
.....
.....
.....
.....
.....
.....
.....
.....
.....
.....
.....
.....
.....
.....
.....
.....



756409