

solar**edge**

# SolarEdge ZigBee Slave Kit Installation Guide

Version 1.0



# Disclaimers

## Important Notice

---

Copyright © SolarEdge Inc. All rights reserved.

No part of this document may be reproduced, stored in a retrieval system, or transmitted, in any form or by any means, electronic, mechanical, photographic, magnetic, or otherwise, without the prior written permission of SolarEdge Inc.

This document is solely for the use of SolarEdge customers and employees.

The material furnished in this document is believed to be accurate and reliable. However, SolarEdge assumes no responsibility for the use of this material. SolarEdge reserves the right to make changes to the material at any time and without notice. You may refer to the SolarEdge web site ([www.solaredge.com](http://www.solaredge.com)) for the most updated version.

All company and brand products and service names are trademarks or registered trademarks of their respective holders.

Patent marking notice: <http://www.solaredge.com/groups/patent>

The general terms and conditions of purchase of SolarEdge products shall apply.

The content of these documents is continually reviewed and amended, where necessary. However, discrepancies cannot be excluded. No guarantee is made for the completeness of these documents.

## FCC Compliance

---

This equipment has been tested and found to comply with the limits for a Class B digital device, pursuant to part 15 of the FCC Rules. These limits are designed to provide reasonable protection against harmful interference in a residential installation. This equipment generates, uses and can radiate radio frequency energy and, if not installed and used in accordance with the instructions, may cause harmful interference to radio communications. However, there is no guarantee that interference will not occur in a particular installation. If this equipment does cause harmful interference to radio or television reception, which can be determined by turning the equipment OFF and ON, you are encouraged to try to correct the interference by one or more of the following measures:

- Reorient or relocate the receiving antenna.
- Increase the separation between the equipment and the receiver or its antenna.
- Connect the equipment into an outlet on a circuit different from that to which the receiver is connected.
- Consult the dealer or an experienced radio/TV technician for help.

Changes or modifications not expressly approved by the party responsible for compliance may void the user's authority to operate the equipment.

# Table of Contents

<b>Disclaimers</b> .....	<b>1</b>
Important Notice .....	1
FCC Compliance .....	2
<b>Table of Contents</b> .....	<b>3</b>
<b>About This Guide</b> .....	<b>4</b>
<b>Support and Contact Information</b> .....	<b>5</b>
<b>Chapter 1: Introducing the ZigBee Communication</b> .....	<b>6</b>
Overview.....	6
Package Contents .....	6
Installation Procedure .....	6
<b>Chapter 2: Installing the ZigBee Module and Antenna</b> .....	<b>7</b>
Installing the Antenna and Cable .....	7
Mounting the Module in the Inverter.....	10
<b>Appendix A: Configuring ZigBee Communication</b> .....	<b>12</b>
<b>Appendix B: Technical Specifications</b> .....	<b>16</b>

## About This Guide

This user guide is intended for Photovoltaic (PV) system owners, installers, technicians, maintainers, and integrators who use the SolarEdge power harvesting system.

This manual describes how to install and set up ZigBee™ communication in a SolarEdge device (inverter or Safety and Monitoring Interface – SMI). The manual instructions and graphics refer to the inverter; however apply to SMI as well.

This guide assumes that the SolarEdge power harvesting system is already installed and commissioned. For additional information about how to install and commission the SolarEdge power harvesting system, refer to the relevant installation guide.

The guide includes the following chapters:

- **Chapter 1: Introducing the ZigBee Communication**, page 6, describes the SolarEdge ZigBee slave module functionality and connection.
- **Chapter 2: Installing the ZigBee Module and Antenna**, page 7, describes how to mount, connect and verify the connection of the ZigBee slave module.
- **Appendix A: Configuring ZigBee Communication**, page 12, describes how to set up the ZigBee communication type in the inverter, if necessary.
- **Appendix B: Technical Specifications** page 16, provides the electrical and mechanical specifications of the SolarEdge ZigBee slave module.

For further information, datasheets and the most up-to-date certifications for various products in different countries, please visit the SolarEdge website: [www.solaredge.com](http://www.solaredge.com)

## Support and Contact Information

If you have technical queries concerning our products, please contact us:

US & Canada	1877 360 5292	<a href="mailto:support@solaredge.us">support@solaredge.us</a>
Germany	+49 89-45459730	<a href="mailto:support@solaredge.de">support@solaredge.de</a>
France	0800917410	<a href="mailto:support@solaredge.fr">support@solaredge.fr</a>
Belgium	080073041	<a href="mailto:support@solaredge.be">support@solaredge.be</a>
Italy	800 784 824	<a href="mailto:support@solaredge.it">support@solaredge.it</a>
Japan	+81.3.5530.9360	<a href="mailto:support@solaredge.jp">support@solaredge.jp</a>
Asia Pacific		<a href="mailto:support_asia@solaredge.com">mailto:support_asia@solaredge.com</a>
Netherlands	08000221089	<a href="mailto:support@solaredge.com">support@solaredge.com</a>
United Kingdom	0800 028 1183	
Greece	00800125574	
Israel	+972 73 240-3118	
Australia	1800 46 55 67	
Worldwide	+972 73 240-3118	
Fax	+972 73 240-3117	

Before contacting SolarEdge, ensure you have the product serial number as appears on its label.

# Chapter 1: Introducing the ZigBee Communication

## Overview

---

ZigBee is a technology that enables wireless connection between several SolarEdge devices. Up to 32 devices may be inter-connected, in a master-slave configuration. One device is the master (either by having a master ZigBee module pre-installed, or by installing the SolarEdge ZigBee master kit (sold separately). All the other modules act as slaves.

## Package Contents

---

- ZigBee slave module
- Antenna
- Mounting clip with RF cable
- This installation guide

## Installation Procedure

---

The following illustrates the steps required for the home gateway installation:

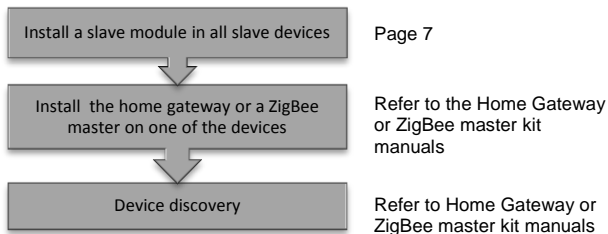



## Chapter 2: Installing the ZigBee Module and Antenna

Install a slave module in all the devices that will communicate with the master ZigBee device (e.g. home gateway).

### Installing the Antenna and Cable

---

- 1 Connect the antenna to the mounting clip.

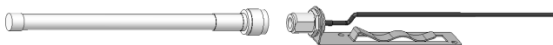

**Figure 1: Connecting the antenna to the mounting clip**

- 2 Attach the mounting clip with the antenna vertically to the top of the inverter. You may attach the clip to the heat sink fins or the inverter side.

Single phase inverter

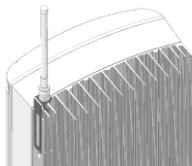

Three phase inverter

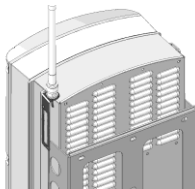

**Figure 2: Antenna mounted on the inverter**

For other SolarEdge devices, or if mounting the antenna not on the inverter top, install the clip on the wall using two screws (not supplied). The antenna must be vertical and far from metal surfaces (including the inverter side).

- 3 Route the antenna cable along the inner fins or the inverter side, in the bracket. Make sure the cable is not hanging loose outside the inverter enclosure.

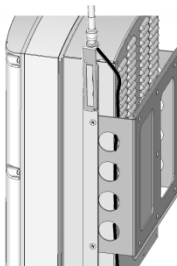

**Figure 3: Routing the antenna cable (Three phase inverter)**

- 4 Disconnect the AC power to the inverter and wait 5 minutes.
- 5 Open the inverter cover as described in its manual.
- 6 Open the gland numbered 1 at the bottom of the SolarEdge inverter.

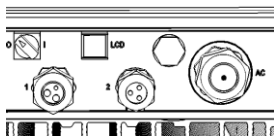

**Figure 4: Inverter sealing glands**

- 7 Remove the rubber seal from the gland and insert the RF cable through the gland cover and the opened connection of the inverter.

- 8 Push the cable into the cut opening of the rubber seal.

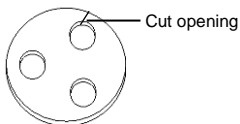
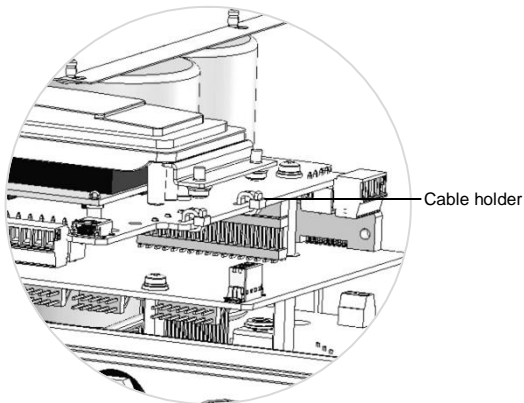

**Figure 5: Rubber seal**

- 9 Insert the rubber seal with the cable into to the gland body and reconnect the gland to the inverter. Tighten the sealing gland.
- 10 Insert the excess of cable length into the inverter until the cable can be tightly attached to the inverter side.

## Mounting the Module in the Inverter

- 1 Connect the ZigBee slave module in its place on the communication board, as shown in Figure 6.  
Follow these guidelines:
  - Use the marking on the communication board to plug in the ZigBee slave module with the correct orientation
  - Insert the ZigBee module such that all pins are correctly positioned in the communication board socket, and no pins are left out of their socket.
  - Make sure that the module is firmly in place.
- 2 Install the two cable holders on the communication board.



**Figure 6: Cable holders on the communication board**

- 3 Route the cable towards the ZigBee module while snapping it into the two cable holders at the side of the communication board.

- 4 Connect the RF cable to the ZigBee slave module and tighten manually.

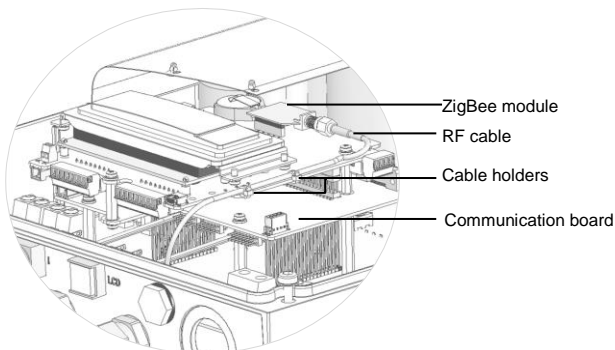

**Figure 7 ZigBee and RF cable on the communication board**

- 5 Close the SolarEdge device cover as described in its manual. Check for proper cover fastening to ensure sealing.
- 6 Turn the SolarEdge device AC power ON.
- 7 The inverter is configured as the slave device by default; therefore, no further configuration is required, unless the default has been changed. In this case, refer to *Appendix A: Configuring ZigBee* on page 12.



**NOTE:**

ZigBee is automatically enabled during the discovery of the inverter by the master. Enabling or configuring ZigBee is not required.

## Appendix A: Configuring ZigBee Communication

The inverter is set by default to slave for the ZigBee connection. ZigBee is automatically enabled during the discovery of the inverter by the master. Enabling or configuring ZigBee is not required. Use this procedure only if the default settings have been changed.

The inverter can be configured using the external LCD light button. When using this option, opening the inverter cover is not required in order to set it up.

It is recommended to keep the gateway close to the inverter during configuration.

### ► To configure the Inverter Using the LCD Light Button:

The following figure illustrates the inverter connector panel:

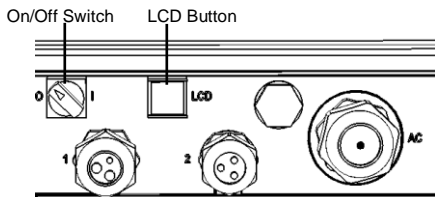

Figure 8: Inverter connector panel

Use the LCD button to toggle through the informative status screens, and for communication setup.

- 1 Verify that the inverter ON/OFF switch is OFF.
- 2 Press the LCD Light button once to turn ON the backlight. If the inverter worked properly before this action, the following message is displayed:

```
D C   V O L T A G E   N O T   S A F E
D O   N O T   D I S C O N N E C T
V D C :           7 2 . 0
```

This message is displayed until the DC is below the safety voltage threshold. The default safety voltage is 50 V.

- 3 Access the Setup mode: Press and hold down the LCD button until the following message is displayed:

```
K e e p   h o l d i n g   b u t t o n
F o r   p a i r i n g ,   r e l e a s e
T o   e n t e r   m e n u ...
R e m a i n i n g           3   s e c
```

Release the button within three seconds to access the Setup Mode. When using setup menus, short press to scroll down to the next menu option and long press to select the item. You can use the Exit option in these menus to move up one menu level.

```
L a n g u a g e
C o m m u n i c a t i o n
I n f o r m a t i o n
M a i n t e n a n c e
E x i t
```

- 4** Scroll down to the **Communication** submenu and select it. (Some of the menu items may vary depending on device and configuration).

```
S e r v e r < L A N >
L A N   C o n f
R S 4 8 5 - 1   C o n f < S >
R S 4 8 5 - 2   C o n f < >
Z i g B e e   C o n f < >
R S 2 3 2   C o n f
S l a v e   D e t e c t
```

- 5** Select the **Server** submenu, scroll down to the **Zigbee** option and select it.

```
L A N
R S 2 3 2
R S 4 8 5
Z i g b e e
N o n e
```

- 6** Scroll down to the **ZigBee Conf** submenu and select it. If **ZigBee Conf <N/A>** indication appears, and ZigBee Conf submenu is not accessible, the ZigBee module is not installed correctly.

```
D e v i c e   T y p e < S E   >
P r o t o c o l < P 2 P >
D e v i c e   I D < 1 >
P A N   I D
S c a n   C h a n n e l
L o a d   Z B   D e f a u l t s
S l a v e   D e t e c t
```



- 7** Select **Protocol** and set it to **Multi-Point Slave (MPS)**.
- 8** Select **Load ZB Defaults**. The default settings are applied to the inverter.
- 9** Exit the Setup mode by selecting the Exit option in each submenu screen or wait for the device to automatically exit Setup mode, if no buttons are pressed for more than two minutes.

This concludes the slave configuration using the LCD button.

## Appendix B: Technical Specifications

Performance			
	North America	Worldwide	Unit
Transmit power	18	10	dBm
Receiver sensitivity	-102		dBm
EIRP with antenna	22	14	dBm
Outdoor (LOS) range*	250		m
Indoor range*	15		m
Regulatory approvals	FCC (USA) IC (Canada) ETSI (Europe) C-Tick (Australia) Telec (Japan)		

---

\* Approximate values, may differ depending on specific installation conditions



If you have technical queries concerning our products,  
please contact our support through SolarEdge service portal:  
<http://www.solaredge.com/groups/support/services>

North America	(Toll free) 1877 360 529 2
Australia	(Toll free) 1800 149 229
Germany	089 454 597 30
France	(Toll free) 0800 917 410
Italy	(Toll free) 0800 784 824
United Kingdom	(Toll free) 0800 028 1183
Belgium	(Toll free) 0800 730 41
Israel	073 240 311 8
Rest of world	+ 1 (0) 650 319 884 3
Fax	+ 972 (0) 73 240 311 7
Email to:	<a href="mailto:support@solaredge.com">support@solaredge.com</a>

[www.solaredge.com](http://www.solaredge.com)

**solar**edge



MAN-01-00128-1.0