

☐☐☐ **LUXOR**

the sunshine people

SOLO LINE:

MODULES CORRECTLY

MOUNTED

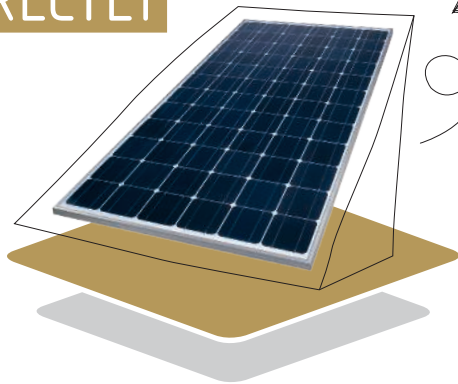
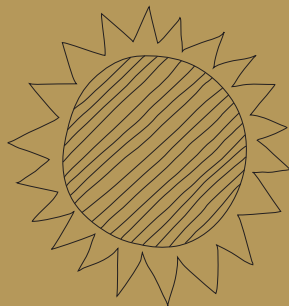

TABLE OF
CONTENTS



04-06

INFORMATION REGARDING
THIS MANUAL

07-08

SAFETY
INSTRUCTIONS

09-13

MECHANICAL
INSTALLATION

14-16

ELECTRICAL
INSTALLATION

17-19

TROUBLESHOOTING,
MAINTENANCE

INFORMATION REGARDING THIS MANUAL

1.1 OBJECT

This manual contains information about the installation and safe handling of Luxor Solar GmbH photovoltaic modules:

- + Solo Line 36 / 5 W (monocrystalline)
- + Solo Line 36 / 10 W (monocrystalline)
- + Solo Line 36 / 50 W (polykrystalline)
- + Solo Line 36 / 80 W (monocrystalline)
- + Solo Line 36 / 120 W (polykrystalline)

These modules are hereinafter referred to as "module" and Luxor Solar GmbH as "Luxor".

1.2 TARGET GROUP

Special skills and expert knowledge are required for the installation of photovoltaic systems. This document is intended for corresponding specialists. This manual must be read and understood prior to installation. In case of any questions, please contact

our sales department for further explanations. During installation of the module, the installer must adhere to all safety precautions in accordance with this manual and to the valid local regulations. Before installation of a photovoltaic system, the installer must become familiar with the mechanical and electrical requirements of such a system. Keep this manual in a safe place for future reference (care and maintenance) and for the case of the sale or disposal of the modules.

1.3 VALIDITY

Luxor reserves the right to make modifications to the modules or assembly instructions at any time without notice.

Please contact Luxor if you have any questions regarding the validity of the documents.

1.4 GUARANTEE AND PROPER USE

The current Luxor guarantee policy for photovoltaic modules shall apply.

1.5 LIABILITY EXCLUSION

As the use of these instructions and the circumstances or methods of installation, operation, use and maintenance of the photovoltaic (PV) products are beyond its influence, Luxor shall not assume any responsibility and explicitly rejects any liability for loss, damage or expenses resulting from or in any way associated with the installation, operation, use or maintenance. Luxor shall not assume responsibility for any infringement of patents or other third-party rights resulting from the use of the PV product. A license under a patent or patent rights shall not be granted, neither by implication nor by any other way. The information in these instructions are based on the knowledge and experience of Luxor and are stated in good faith. This information, including the product specifications (without restrictions) and suggestions, neither represent an explicit nor implied guarantee. Luxor reserves the right to change the instructions,

the PV product, the specifications or product information sheets without notice.

1.6 USED SYMBOLS

The following symbols are used in the manual:



Warning of life-threatening injuries
in case of non-observance



Warning of material damage
in case of non-observance



Indication of useful
information

1.7 REGULATORY PROVISIONS

All technical rules for planning, installation and operation of PV systems must be adhered to.

The following standards and regulations merely represent an excerpt:

- + DIN VDE 0100 Installation of power installations with nominal voltages up to 1,000 V
- + VDI 6012 p. 2 Local energy systems in buildings
- + DIN 1055 Load assumptions for structures
- + VDE 0185 Lightning protection
- + BGR 203 Safety regulations of the trade association for roof work
- + BGV A2, A3 Electrical systems and equipment
- + Regulations of the central organisation of the German roofing craft – professional association of roofing, wall and waterproofing technology
- + Regulations of the local grid operators
- + Regional building regulations

1.8 PRODUCT IDENTIFICATION

Each module has labels on the back containing the following information:

- + Identification label: describes the product type; rated output, rated current, rated voltage, open circuit voltage, short circuit current acc. to the standard conditions, as well as the maximum system voltage, dimensions and weight and the position of the mounting holes and other technical specifications can be taken from the datasheets provided.
- + Barcode: Each individual module has a unique serial number. There is only one barcode on each module. It is permanently attached to the inside of the module and is visible from the front. This barcode is inserted before lamination



Caution!

Removal or defacing of one or several labels is not permissible! In case of infringement, all guarantee claims become null and void!

SAFETY INSTRUCTIONS



2.1 HAZARD WARNINGS

- + Installation may only be performed by specialists.
- + Keep children away from the system during the transport and installation of the mechanical and electrical components.
- + Installers are liable themselves for the entire risk with regard to accidents and injuries during installation, including but not restricted to injuries caused by electric shock.
- + Please adhere to the safety instructions for working with direct current.
- + A single module can generate direct current voltages of more than 30 volts in direct sunlight. In case of series connection of the modules, the total voltage corresponds with the total of the individual module voltages. If the modules are connected in parallel, the total current strength corresponds with the total of the current strengths of the individual modules. Even contact with a direct current voltage of 30 volts or higher is potentially dangerous.
- + Never disconnect the module under load. Before working on the PV system, disconnect the AC and DC inverter circuits.
- + Cover the module fully with a non-transparent material during installation to avoid the generation of current.
- + Only use insulated tools approved for working on electrical equipment. Do not insert any electrically conducting parts into the ports of the modules.
- + Do not carry out any work on the PV system in case of wet weather conditions or strong winds.
- + Use proper fall arrest systems on the roof.
- + Adhere to the safety regulations for all other components used in the system including cables, plugs, charge controllers, inverters, accumulator batteries, rechargeable batteries etc.

2.2 WARNING OF MATERIAL DAMAGE



- + The proper conception of the rack is the responsibility of the system designers and installers.
- + Never short-circuit the modules.
- + Only use equipment, connections, cables and racks suitable for an electric solar system.
- + Always use the same type of module within a certain PV system.
- + Do not use defective or damaged modules.
- + Do not attempt to disassemble the module, and do not remove any of the existing identification labels or components from the module.
- + No colouring agents or adhesives may be applied to the top surface of the module.
- + Do not use any mirrors or other magnifying equipment to artificially concentrate the sunlight onto the modules.
- + Do not expose the rear film to direct sunlight.
- + Do not use the module near equipment or in places where flammable gases are generated or may accumulate.
- + Do not drill any additional mounting holes in the module frames. The guarantee becomes null and void in case of infringement.
- + Do not attempt to drill any holes in the glass surface of the modules. The guarantee becomes null and void in case of infringement.
- + Do not lift the module by the junction box or the electrical cables.
- + Do not stand on or step onto the module. Do not place any heavy objects on the module.
- + Avoid dropping the module and do not set it down jerkily. Prevent objects from falling onto the module.
- + When installing the system you must adhere to all local, regional and national ordinances. If applicable, apply for a building permit.

MECHANICAL INSTALLATION

3.1 SELECTION OF THE LOCATION

- + Select a suitable location for the installation of the modules. Modules can be installed on the ground, on roofs, vehicles or waterborne vessels.
- + In northern latitudes, the modules should be orientated towards the south and vice versa. You will find detailed information about the best angle of inclination for installation in specialised literature or from an experienced solar installer or system designer.
- + Shading, including temporary shading or partial shading must be avoided.
- + The modules are evaluated at Fire Classification C and can be mounted on Class A roofs.

3.2 DIMENSIONAL MODULE DRAWINGS

Rear/front/side view*

* Tolerance L/W = +/- 3 mm, H = the dimensions in the order confirmation are decisive

** Position upon request

LX - 10 M

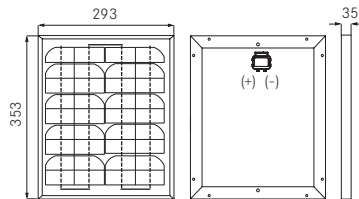

LX - 5 M

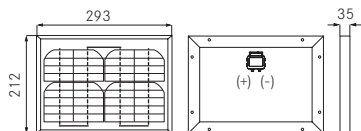

LX - 50 P

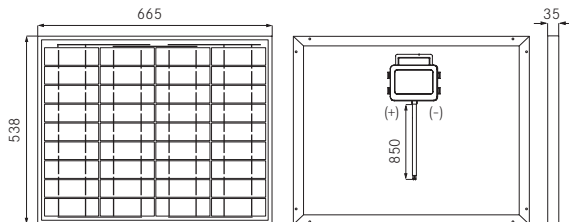

LX-80M

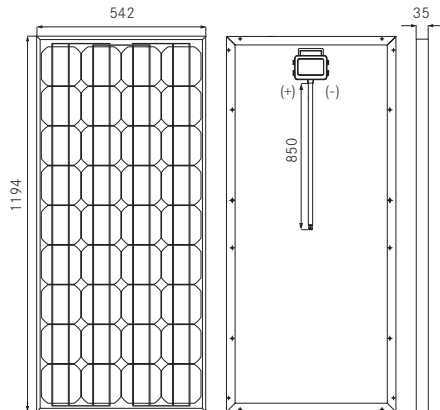

LX-120 P

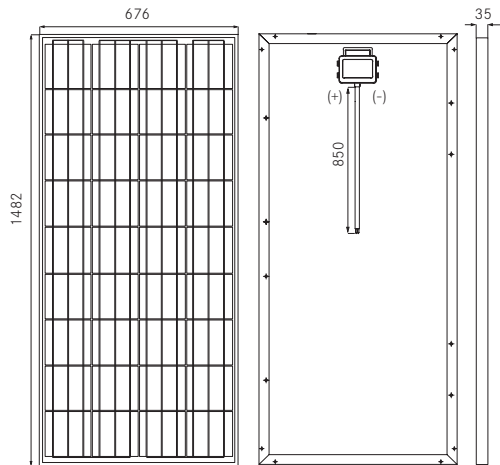

3.3 SELECTION OF A SUITABLE ASSEMBLY RACK

- + The assembly rack for the module must be made of durable, corrosion- and UV-resistant material.
- + The assembly rack must be sufficiently sized for the regionally occurring snow and wind loads.
- + The modules with the four anchorage points must be securely fastened to the assembly rack. Additional anchorage points must be provided in case of the occurrence of increased snow and wind loads. Please refer to the following drawing for detailed information. Load calculations are performed by the system designer or installer.
- + Depending on the assembly rack, the modules can be fastened to the assembly rack by means of bolted connections or module clamps.
- + Adhere to the instructions and safety precautions of the assembly rack manufacturer.

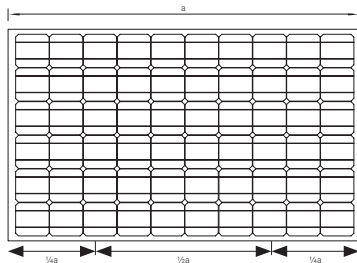

Solo Line 36 / 5 W: $a = 293 \text{ mm}$

Solo Line 36 / 10 W: $a = 353 \text{ mm}$

Solo Line 36 / 50 W: $a = 685 \text{ mm}$

Solo Line 36 / 80 W: $a = 1194 \text{ mm}$

Solo Line 36 / 120 W: $a = 1482 \text{ mm}$

3.4 TYPES OF ASSEMBLY



Caution!

Danger of material damage!

Treat the modules with great care during unpacking, transport and assembly. Do not enter the modules. Avoid torsion. Do not use the cables or junction box as a handle.



Caution!

Danger of material damage!

Only use the existing mounting holes in the module frame (see dimensional drawing).

Do not carry out any independent modifications on the module.

Depending on the module type, they have 8 or 16 ventilation openings and 4 drainage openings in the module frame. During assembly, make sure that these openings are not covered. Keep a distance of 5 millimetres between the modules, as they expand slightly when heated.

If possible, the modules should be mounted at an installation angle of at least 15° in order to support their self-cleaning effect.

The modules are suitable for on-roof, in-roof or free-standing installation. Rod and mast mounting are also possible.

FREE-STANDING INSTALLATION

During free-standing installation, particularly if located close to the ground, attention must be paid that the lower module area is also not covered with snow for

a long period of time in regions with heavy snowfall. Furthermore it must be ensured that the module is not located in the shade of plants or trees and that it is not damaged by flying sand and stones in strong winds.

In case of several rows of modules, reciprocal shading must be prevented by adhering to appropriate minimum distances.



Caution!

Danger of insufficient fastening!

For free-standing installation on flat roofs, an edge clearance in accordance with DIN 1055 Part 4 must be observed.

ROOF-PARALLEL MOUNTING

Sufficient rear ventilation of the modules must be ensured for roof-parallel mounting (at least 100 mm airspace between the module and the mounting surface).

Each penetration required for the installation of the module must be properly sealed to prevent the roof from leaking.

ELECTRICAL INSTALLATION

4.1 DESIGN

The electrical nominal values are within a range of ± 3 percent of the stated values of I_{sc} , U_{oc} and P_{max} under standard test conditions (radiation density of $1,000 \text{ W/m}^2$, AM 1.5 spectrums and a cell temperature of $25 \text{ }^\circ\text{C}$) in the sense of the tolerances of the measuring instruments used.

In normal outdoor use conditions, the current strength and voltage produced by the module deviate from the values stated on the datasheet. The datasheet values are the values achieved under standard test conditions. The short circuit current values and the open circuit voltage values should be correspondingly multiplied by a factor of 1.25 during system design in order to be able to sufficiently size the component voltage, current load capacity of the conductors, size of the fuses and size of the regulating devices connected to the modules or to the system output. The open circuit voltage of the PV system must not

exceed the maximum permissible input voltage of the inverter used and the maximum system voltage acc. to the module datasheet (5 | 10 = 150 V, 50 = 400 V, 80 | 120 = 1000 V). The maximum system voltage of other system components must also be observed. Do not use modules with different configurations in the same system.

Highest number of modules (N) = $U_{max} \text{ system} / [U_{oc} \text{ (with STC)}]$

The cross-sectional area of the cable and the connection capacity must correspond with the highest short circuit current of the system (the recommended cross-sectional area of the cable is 2.5 mm^2 (5W, 10W) respectively 4 mm^2 (50W, 80W, 120W) for a single module, as otherwise the cable and the connection over heat at high current strength.

The modules fulfil the requirements of application class A (IEC 61730), protection class II.

The direct current generated by photometric systems can be converted into alternating current and fed into the local grid. As the grid operators have different infeed conditions from town to town for the connection of renewable energy systems, contact with the responsible grid operator should be made in due time. Approvals for the installation of such a system are usually required (application for grid connection). Connection to the grid may only be carried out by a licensed electrician.



Please refer to the valid module datasheet for detailed module data. The electrical rated parameters of the modules are also stated on the module type plate.

4.2 EARTHING



Caution!
Danger of material damage!
Please observe the local regulations and provision for earthing.



Caution!
Danger of material damage!
Bolts, screws or other earthing connections may not be used to fasten the module to the assembly rack.

The modules have two holes (2 mm) on the back for fastening the potential equalisation in the module frame.

4.3 CABLING



Caution!
Danger of electric shock!
Please observe the safety instructions for working with direct current!



Caution!
Danger of electric shock and burns!
Do not disconnect the plug-in module connections under load! Otherwise non-extinguishing electric arcs may result.

Only use cables and connectors which are suitable for an outdoor use and for solar applications. Ensure the right polarity when connecting them. At the 5W and

10W module the polarity is marked at the connection terminals in the junction box, at the 50W, 80W and 120W module at the connection cable. Do not bend the cables and observe the minimum bending radius. Please make sure that the cables are laid such that they cannot rub against sharp-edged objects or roof tiles. UV-resistant cable ties, for example, are suitable for fastening. Some mounting systems also have special cable fastenings and guides. Make sure the cables are not installed under tensile stress. Replace damaged cables.

If possible, ensure short cable lengths to minimise intrinsic losses.

Please check the open circuit voltage and the short circuit current for each installed strand (see also section 4.4).

4.4 TEST

Test all electric and electronic components of the system before use. Follow the instructions in the manuals provided with the components and equipment. Perform a test of the open circuit voltage and short circuit current before connection of the system.

OPEN CIRCUIT VOLTAGE

Check the open circuit voltage of each strand with a digital multimeter. The measured values should correspond with the total of the open circuit voltage for the individual modules. You will find the nominal voltage in the datasheet of the module used*. If the measured value is substantially lower than the expected value, continue in accordance with the section "Troubleshooting at low voltage".

SHORT CIRCUIT CURRENT

Test the short circuit current of each series circuit. This can be measured directly with a digital multimeter, which is connected to two clamping plates of the series circuit or module, or with any load, such as e. g. PV lighting, in order to carry out a rough measurement. Please make sure that the nominal scale of the ampere meter or the rated current of the load must amount to 1.25 times the rated short circuit current of the series module. You will find the rated current in the datasheet of the module used. The measured value can vary strongly depending on the weather, time of day and possibly the shade.

* The electrical values of the provided individual measurements allocated to the respective serial number are decisive.

TROUBLESHOOTING AND MAINTENANCE

5.1 BLOCK DIODES AND BYPASS DIODES



Caution!
Danger of electric shock!

Please observe the safety instructions for working with direct current.



Caution!
Danger of electric shock!

Never disconnect the module under load. Before working on the PV system, disconnect the AC and DC inverter circuits. Cover the module fully with a non-transparent material during installation to avoid the generation of current.

For systems with more than two in-series modules, high counter-current may flow through shaded solar cells, if only part of the module is affected by shade while the other part is exposed to sunlight. This current flow can cause the affected cells to overheat,

thus damaging the module. Bypass diodes are used in the module to protect it from such high reverse current. All modules of these series already have bypass diodes integrated into the junction box. In the improbable case of a diode failure, it can be easily replaced.



Request the type of diode required for replacement from Luxor, stating the type of module and the serial number.

5.2 TROUBLESHOOTING AT LOW VOLTAGE

First of all, determine whether this is normal or excessive low voltage.

In the case of normal low voltage there is a drop in the open circuit voltage in the module, caused by a temperature increase of the solar cells or lower radiation density.

Excessive low voltage is usually caused by defective connections at the terminals or defective bypass diodes.

- + First test all cable connections to make sure that there is no open circuit or faulty connection.
- + Test the open circuit voltage of each module.
- + Cover the modules with a non-transparent material.
- + Disconnect the connection at both module ports.
- + Remove the non-transparent material from the test module and measure the open circuit voltage at the connections.
- + If the measured voltage is only half the rated value, you can assume that the bypass diode is damaged. For further information, please refer to the section "Block diodes and bypass diodes".
- + If the radiation density is not very low and the voltage between the terminals deviates by more than 5%, then it is probable that the port is defective.

5.3 MAINTENANCE



Caution!
Danger of electric shock!

The earthing of the modules may not be interrupted or destroyed by maintenance and repair work.



Caution!
Danger of damage to the modules!

Avoid scratches and damage to the glass surface. Do not use aggressive, abrasive or hard cleaning agents.

Luxor recommends the following maintenance for optimum module performance:

- + Clean the glass surface of the module as required. Always use water and a soft sponge or cloth for cleaning. A mild, non-abrasive cleaning solution can be used for the removal of stubborn dirt.
- + Check the electrical and mechanical connections every six months to ensure that they are clean, safe and undamaged.

- + If a fault should occur, please contact a specialist. Important: Follow all maintenance instructions for all system components including the racks, charge controllers, inverters, rechargeable batteries etc.

5.4 RETURNING AND DISPOSAL

Sustainability is a high-priority topic for Luxor. This is why modules for disposal can be returned to Luxor for recycling.

Submission of the delivery note or invoice stating the date of purchase is required when returning. The existing conditions on the Luxor Internet site or as described in another appropriate way that are respectively valid at the time of return apply for the return and disposal system.

Please do not hesitate to contact Luxor if you have any questions.

□□□ **LUXOR**
the sunshine people

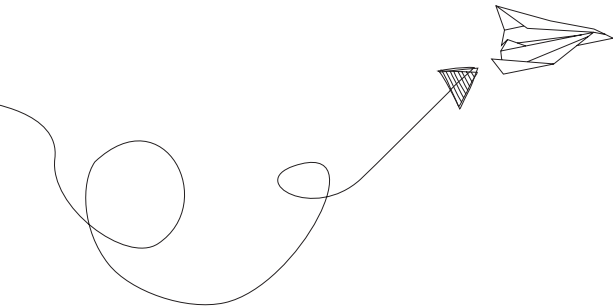

Luxor Solar GmbH

Königstraße 26 | 70173 Stuttgart | Germany
T +49.711.88 888-999 | F +49.711.88 888-911
info@luxor-solar.com | www.luxor-solar.com

Printed on Recycstar Polar, a recycling paper with FSC certificate
and the "Blue Angel" eco-label.



ClimatePartner[®]
klimaneutral
gedruckt

Zertifikatsnummer:
778-53212-0511-1068
www.climatepartner.com