

# JinkoSolar Photovoltaic Module



## Installation Manual

## Contents

1	General Information	1
1.1	Overview	1
1.2	Applicable Products	1
1.3	Warnings	2
<hr/>		
2	Installation	5
2.1	Installation safety	5
2.2	Installation Condition	6
2.2.1	Climate condition	6
2.2.2	Site selection	6
2.2.3	Tilt angle selection	7
2.3	Mechanical Installation introduction	7
2.3.1	Fixation with screws	8
2.3.2	Fixation with clamps at long sides of frames	11
2.3.3	Fixation with clamps at short sides of frames	16
2.3.4	Fixation with clamps at the long & short sides	19
2.3.5	Fixation with screws & clamps at the long & short sides	22
<hr/>		
3	Wiring and connection	24
<hr/>		
4	Maintenance and care	26
4.1	Visual Inspection	26
4.2	Cleaning	27
4.3	Inspection of Connector and Cable	27
<hr/>		
5	Electrical specification	27
<hr/>		
6	Disclaimer of Liability	28
<hr/>		

## 1. General Information

### 1.1 Overview

Thanks for choosing Jinko Solar PV modules. In order to ensure the PV modules to be installed correctly, please read the following operation instructions carefully before modules to be installed and used.

Please remember that the products would generate electricity, thus certain safety measures need to be taken to avoid danger.

### 1.2 Applicable Products

This document is applicable to the series of solar module as listed below:

With 6" poly and mono c-Si:

JKMxxxP-60/JKMxxxPP-60\*/JKMxxxP-60-J/JKMxxxPP-60-J/JKMxxxP-60B/JKMxxxP-60(Plus)\*\*/JKMxxxPP-60(Plus)/JKMSxxxP-60\*\*\*/JKMSxxxP-60-J/JKMSxxxP-60(Plus)/JKMSxxxP-60B\*\*\*\*

(XXX=210~280, in increment of 5)

JKMxxxP-72/JKMxxxPP-72/JKMxxxP-72-J/JKMxxxPP-72-J/JKMxxxP-72B/JKMxxxP-72(Plus)/JKMxxxPP-72(Plus)/JKMSxxxP-72/JKMSxxxP-72-J/JKMSxxxP-72(Plus)/JKMSxxxP-72B

(XXX=250-340, in increment of 5)

JKMxxxM-60/JKMxxxM-60-J/JKMxxxM-60(Plus)/JKMxxxM-60B/JKMSxxxM-60/JKMSxxxM-60-J/JKMSxxxM-60(Plus)

(XXX=210~280, in increment of 5)

JKMxxxM-72/JKMxxxM-72-J/JKMxxxM-72(Plus)

/JKMxxxM-72B/JKMSxxxM-72/JKMSxxxM-72-J/JKMSxxxM-72(Plus)

(XXX=250-335, in increment of 5)

JKMxxxP-48/JKMxxxPP-48/JKMxxxP-48-J/JKMxxxPP-48-J/JKMxxxP-48(Plus)/JKMxxxPP-48(Plus)/JKMSxxxP-48/JKMSxxxP-48-J/JKMSxxxP-48Plus)  
(XXX=170~225, in increment of 5)

With 5" mono c-Si:

JKMxxxM-72/JKMxxxM-72-J/JKMxxxM-72B/JKMSxxxM-72/JKMSxxxM-72-J  
(XXX=160~215, in increment of 5)

JKMxxxM-96/JKMxxxM-96-J/JKMxxxM-96B/JKMSxxxM-96/JKMSxxxM-96-J  
(XXX=210~285, in increment of 5)

Notes:

\*PP: the EAGLE Series module

\*\* (Plus): the eagle+ Series module

\*\*\*JKMS: the smart module

\*\*\*\*B: module with black back sheet

Make sure the array of modules installed within the Maximum permitted system voltage and the rating current and voltage of the sub-equipments such as regulators and inverters. The maximum permitted system voltage (DC) of the modules sold in Europe is 1000V

The assembly is to be mounted over a fire resistant roof covering rated for the application. Before mounting the module, please consult your local building department to determine approved roofing materials.

The modules are qualified for application class A: Hazardous voltage (IEC 61730: higher than 50V DC; EN 61730: higher than 120V), hazardous power applications (higher than 240W) where general contact access is anticipated (Modules qualified for safety through EN IEC 61730-1 and -2 within this application class are considered to meet the requirements for Safety Class II.

### 1.3 Warnings



- PV modules generate DC electrical energy when exposed to sunlight or other light sources. Active parts of module such as terminals can result in burns, sparks, and lethal shock.
- Artificially concentrated sunlight shall not be directed on the module or panel.



- Front protective glass is utilized on module. Broken solar module glass is an electrical safety hazard (may cause electric shock and fire). These modules cannot be repaired and should be replaced immediately.

 <p>Warning</p>	<ul style="list-style-type: none"><li>◆ Electric Shock and Burn Hazard</li><li>◆ This photovoltaic module produces Electricity when exposed to the sun</li></ul>
--	--

- To reduce the risk of electrical shocks or burns, modules may be covered with an opaque material during installation to avoid shocks or burns.
- The installation work of the PV array can only be done under the protection of sun-sheltering covers or sunshades and only qualified person can install or perform maintenance work on this module.
- Follow the battery manufacture's recommendations if batteries are used with module.
- Do not use this module to replace or partly replace roofs and walls of living buildings.
- Do not install modules where flammable gas may be present.
- Do not touch live terminals with bare hands. Use insulated tools for electrical connections.

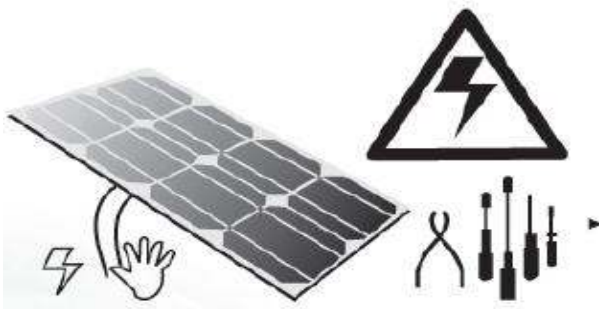

Use insulated tools for electrical connection

- Do not remove any part installed by Jinko Solar or disassemble the module.
- All instructions should be read and understood before attempting to install, wire, operate and maintain the module.
- Please don't lift up PV modules using the attached cables or the junction box.
- All PV systems must be earthed. If there is no special regulation, please follow the National Electrical Code or other national code.
- Under normal conditions, a photovoltaic module is likely to experience conditions that produce more current and/or voltage than reported at standard test conditions. Accordingly, the value of Isc and Voc marked on this module should be multiplied by 1.25 when determining PV system component voltage ratings, conductor current ratings, fuse sizes, and size of controls connected to the PV output.
- Once the PV module has been shipped to the installation site, all of the parts should be unpacked properly with care.
- Do not stand or step on the PV module like below pictures show, this is prohibited and there can be risks of micro-crack which may cause a sharp decline of module's power performance; what's more, it may threaten your safety.

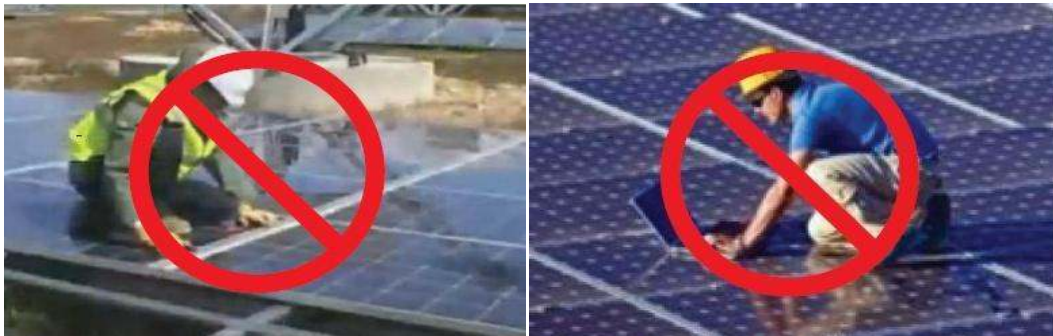

- Only PV modules with the same cell size should be connected in series.
- During all transportation situations, please make sure no huge shock for the vehicle or the modules, as this may damage the module or lead the cell to be crack.
- During all transportation situation, never let the module fall down from the vehicle, house or hands. This will break the cells of the modules.
- Do not clean the glass with chemicals.
- Do not disconnect any of the modules when it is under load.

## 2. Installation

### 2.1 Installation safety

- Always wear protective head gear, insulating gloves and safety shoes (with rubber soles).
- Keep the PV module packed in the carton until installation.
- Do not touch the PV module unnecessarily during installation. The glass surface and the frame may be hot. There is a risk of burns and electric shock.
- Do not work in rain, snow or windy conditions.
- Due to the risk of electrical shock, do not perform any work if the terminals of the PV module are wet.
- Use insulated tools and do not use wet tools.
- When installing PV modules, do not drop any objects (e.g., PV modules or tools).
- Make sure flammable gasses are not generated or present near the installation site.
- Insert interconnect connectors fully and correctly. Check all connections.  
The interconnect cable should be securely fastened to the module frame, Cable support should be done in a way to avoid the connector from scratching or impacting the back sheet of the module.
- Do not touch the junction box and the end of the interconnect cables (connectors) with bare hands during installation or under sunlight, regardless of whether the PV module is connected to or disconnect from the system.
- Do not expose the PV module to excessive loads on the surface of the PV module or twist the frame.
- Do not hit or put excessive load on the glass or back sheet, this may break the cells or cause micro crack.
- During the operation, don't use sharp tools to wipe the back sheet and glass. It would leave scratch on the module.
- Do not drill holes on the frame. It may cause corrosion of the frame.
- For roof mounting structure, when install the modules, please try to follow the "from top to bottom" and/or "from left to right" principle, and don't step on the module, that will damage the module and would be dangerous for personal safety.

## 2.2 Installation Condition

### 2.2.1 Climate condition

Please install the modules in the following conditions:

- a) Operating temperature: within  $-40^{\circ}\text{C}$  ( $-4^{\circ}\text{F}$ ) to  $85^{\circ}\text{C}$  ( $185^{\circ}\text{F}$ )
- b) Humidity:  $< 85\text{RH}\%$

\* Note: The mechanical load bearing (include wind and snow loads) of the module is based on the mounting methods. The professional system installer must be responsible for mechanical load calculation according to the system design.

### 2.2.2 Site selection

In most applications, Jinko solar PV modules should be installed in a location where they will receive maximum sunlight throughout the year. In the Northern Hemisphere, the module should typically face south, and in the Southern Hemisphere, the modules should typically face north. Modules facing 30 degrees away from true South (or North) will lose approximately 10 to 15 percent of their power output. If the module faces 60 degrees away from true South (or North), the power loss will be 20 to 30 percent.

When choosing a site, avoid trees, buildings or obstructions, which could cast shadows on the solar photovoltaic modules especially during the winter months when the arc of the sun is lowest over the horizon. Shading causes loss of output, even though the factory fitted bypass diodes of the PV module will minimize any such loss. Do not install the PV module near naked flame or flammable materials.

When solar modules are used to charge batteries, the battery must be installed in a manner, which will protect the performance of the system and the safety of its users. Follow the battery manufacturer's guidelines concerning installation, operation and maintenance recommendations. In general, the battery (or battery bank) should be away from the main flow of people and animal traffic. Select a battery site that is protected from sunlight, rain, snow, debris, and is well ventilated. Most batteries



generate hydrogen gas when charging, which can be explosive. Do not light matches or create sparks near the battery bank. When a battery is installed outdoors, it should be placed in an insulated and ventilated battery case specifically designed for the purpose.

Do not install the PV module in a location where it would be immersed in water or continually exposed to water from a sprinkler or fountain etc.

### 2.2.3 Tilt angle selection

The tilt angle of the PV module is measured between the surface of the PV module and a horizontal ground surface (Figure 1). The PV module generates maximum output power when it faces the sun directly.

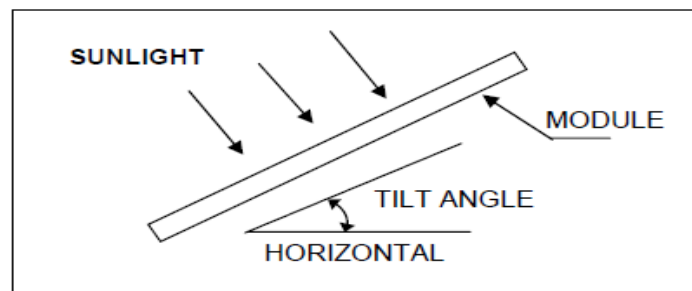

Figure1: PV module tilt angle

For standalone systems with batteries where the PV modules are attached to a permanent structure, the tilt angle of the PV modules should be selected to optimize the performance based on seasonal load and sunlight. In general, if the PV output is adequate when irradiance is low (e.g., winter), then the angle chosen should be adequate during the rest of the year. For grid-connected installations where the PV modules are attached to a permanent structure, PV modules should be tilted so that the energy production from the PV modules will be maximized on an annual basis.

## 2.3 Mechanical Installation introduction

Solar PV modules usually can be mounted by using the following methods: screws and clamps.

**\* Note:**

- 1) All installation methods herein are only for reference, and Jinko solar will not provide related mounting components, the system installer or trained professional personnel must be responsible for the PV system's design, installation, and mechanical load calculation and security of the system.
- 2) Before installing, you should confirm below important things:
  - 1) Visual check before installation, to make sure there is no bug in the packing and junction box as well as the surface of module, If have , remove and clean it .
  - 2) Check the series number is right or not.
- 3) Jinko modules are designed to meet a maximum positive (or downward) pressure of 5400Pa (Only refer to the mentioned module type in this manual) and negative (or upward)pressure of 2400Pa. When mounting modules in snow-prone or high-wind environments, Special care should be taken to mount the modules in a manner that provides sufficient design strength while meeting local code requirements.

### **2.3.1 Fixation with screws**

The applicable products please refer to table 1.

The frame of each module has 8 mounting holes (Length\* Width: 14mm\*9mm) used to secure the modules to support structure. Always use all the eight mounting holes to secure the modules. The module frame must be attached to a mounting rail using M8 corrosion-proof screws together with spring washers and flat washers in eight symmetrical locations on the PV module. The applied torque value should be big enough to fix the modules steadily. The reference value for M8 screw is 16~20N\*m. As to special support system or special installation requirement, please reconfirm with the support's supplier for the torque value. Please find detailed mounting information in the below illustration as Figure 2.

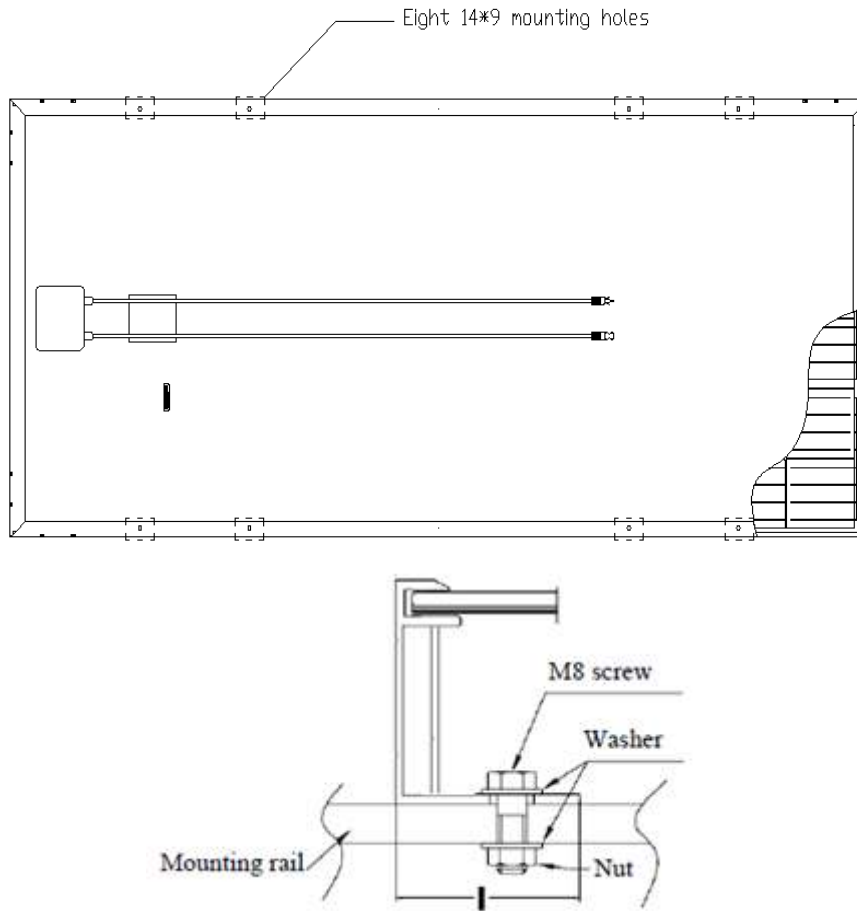

Figure 2: PV module installed with Screw fitting method

Module type	Cell type	Cell	Pmax	Dimensions(mm)
JKMXXXM-72 JKMXXXM-72-J JKMXXXM-72B	5 inch Mono	6*12	160~215Wp	Module:1580*808 Frame: 35*25 & 35*35 & 40*30 & 40*35 & 45*35 & 50*35
JKMXXXM-96 JKMXXXM-96-J JKMXXXM-96B	5 inch Mono	8*12	210~285Wp	Module:1575*1082 Frame: 40*30 & 40*35 & 45*35 & 50*35
JKMXXXP-60 JKMXXXP-60-J JKMXXXPP-60 JKMXXXPP-60-J JKMxxxP-60(Plus) JKMxxxPP-60(Plus) JKMXXXP-60B	6 inch Poly	6*10	210~280Wp	Module:1650*992 Frame:40*30 & 40*35 & 45*35 & 50*35 & 35*35 Module:1650*990 Frame: 40*35

JKMXXXM-60 JKMXXXM-60-J JKMxxxM-60-(Plus) JKMXXXM-60B	6 inch Mono	6*10	210~280Wp	Module:1650*992 Frame:40*30 & 40*35 & 45*35 & 50*35 & 35*35
JKMXXXP-72 JKMXXXP-72-J JKMXXXPP-72 JKMXXXPP-72-J JKMSxxxP-72(Plus) JKMXXXP-72B	6 inch Poly	6*12	250~340Wp	Module:1956*992 Frame: 40*30 & 40*35 & 50*35
JKMXXXM-72 JKMXXXM-72-J JKMxxxM-72(Plus) JKMXXXM-72B	6 inch Mono	6*12	250~335Wp	Module:1956*992 Frame: 40*30 & 40*35 & 50*35
JKMSXXXM-72 JKMSXXXM-72-J	5 inch Mono	6*12	160~215	Module:1580*808 Frame:35*35 & 40*30 & 40*35 & 45*35 & 50*35
JKMSXXXM-96 JKMSXXXM-96-J	5 inch Mono	8*12	210~280	Module:1575*1082 Frame: 40*30 & 40*35 & 45*35 & 50*35
JKMSXXXP-60 JKMSXXXP-60-J JKMSxxxP-60(Plus)	6 inch Poly	6*10	210~280	Module:1650*992 Frame: 40*30 & 40*35 & 45*35 & 50*35
JKMSXXXP-72 JKMSXXXP-72-J JKMSxxxP-72(Plus)	6 inch Poly	6*12	250~340	Module:1956*992 Frame: 40*30 & 40*35 & 50*35
JKMSXXXM-72 JKMSXXXM-72-J JKMSxxxM-72(Plus)	6 inch Mono	6*12	250~335	Module:1956*992 Frame: 40*30 & 40*35 & 50*35
JKMxxxM-48 JKMxxxM-48-J	6 inch Mono	6*8	170~220	Module:1324*992 Frame: 40*35
JKMSxxxM-48-J JKMSxxxM-48(Plus)	6 inch Mono	6*8	170~220	Module:1324*992 Frame: 40*35
JKMxxxP-48 JKMxxxPP-48 JKMxxxPP-48-J JKMxxxPP-48(Plus)	6 inch Poly	6*8	170~225	Module:1324*992 Frame: 40*35
JKMSxxxP-48-J JKMSxxxP-48(Plus)	6 inch Poly	6*8	170~225	Module:1324*992 Frame: 40*35

**Max. Pressure:** 5400Pa mechanical load

**Table 1: Mechanical dimensions when modules installed with Screw fitting method**

### 2.3.2 Fixation with clamps at long sides of frames

The applicable Products please refer to Table 2, and only allow using clamps at long side of frames.

The module clamps should not come into contact with the front glass and must not deform the frame. Be sure to avoid shadowing effects from the module clamps. The module frame is not to be modified under any circumstances. When choosing this type of clamp-mounting method, please be sure to use at least four clamps on each module, two clamps should be attached on each long sides of the module. Depending on the local wind and snow loads, if excessive pressure load is expected, additional clamps or support would be required to ensure the module can bear the load. The applied torque value should be big enough to fix the modules steadily (Please consult with the clamp or support's supplier for the specific torque value). Please find detailed mounting information in the below illustration, the mounting place distance is suggested bigger than J and less than K, as shown below in Figure 3&4.

#### 1) Normal PV module (at long side):

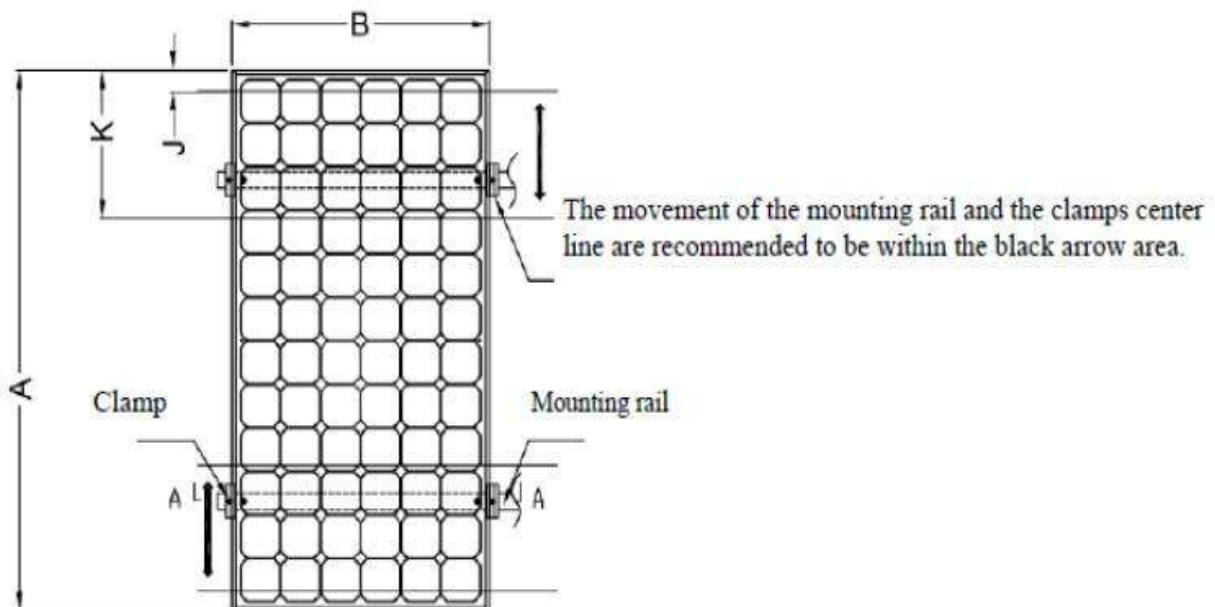

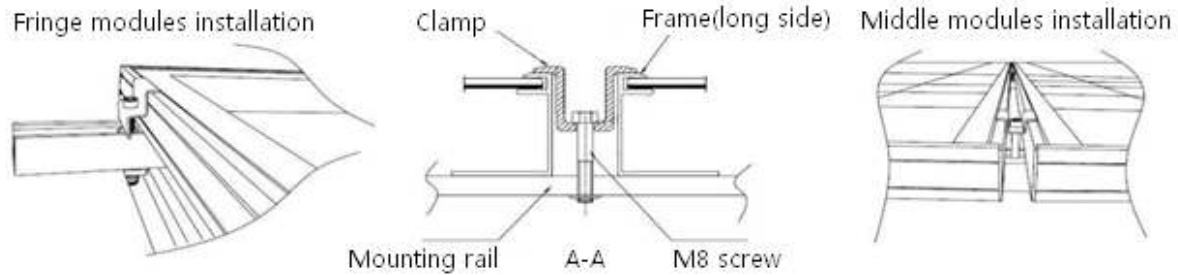

**Figure 3: PV module installed at long side with Clamp fitting method**

Module type	Cell type	Cell quantity	Pmax (Wp)	Dimension(mm)			
				A*B	J	K	Frame
JKMSXXXM-72 JKMSXXXM-72-J	5 inch Mono	6*12	160~215	1580*804	300	400	30*20 & 35*25 & 40*20
				1580*808	300	400	30*20 & 35*25 & 35*35 & 40*30 & 40*35 & 45*35 & 50*35
JKMSXXXM-96 JKMSXXXM-96-J	5 inch Mono	8*12	210~280	1580*1060	280	400	40*30 & 40*20
				1575*1082	280	400	40*20 & 40*30 & 45*35 & 50*35
JKMSXXXP-60 JKMSXXXP-60-J JKMSxxxP-60(Plus)	6 inch Poly	6*10	210~280	1650*992	280	420	35*25 & 40*20 & 40*30 & 40*35 & 45*35 & 50*35
JKMSXXXM-60 JKMSXXXM-60-J JKMSxxxM-60(Plus)	6 inch Mono	6*10	210~280	1650*992	280	420	35*25 & 40*20 & 40*30 & 40*35 & 45*35 & 50*35
JKMSXXXP-72 JKMSXXXP-72-J JKMSxxxP-72(Plus)	6 inch Poly	6*12	250~335	1956*992	280	480	40*20 & 40*30 & 50*35 & 40*35
JKMSXXXM-72 JKMSXXXM-72-J JKMSxxxM-72(Plus)	6 inch Mono	6*12	250~335	1956*992	280	480	40*20 & 40*30 & 50*35 & 40*35
JKMXXXM-72 JKMXXXM-72-J JKMXXXM-72B	5 inch Mono	6*12	160~215	1580*808	300	400	35*25 & 30*20 & 35*35 & 40*30 & 40*35 & 45*35 & 50*35
JKMXXXM-96 JKMXXXM-96-J JKMXXXM-96B	5 inch Mono	8*12	210~285	1575*1082	280	400	40*20 & 40*30 & 40*35 & 45*35 & 50*35

JKMXXXP-60 JKMXXXP-60-J JKMXXXPP-60 JKMXXXPP-60-J JKMxxxP-60(Plus) JKMxxxPP-60(Plus) JKMXXXP-60B	6 inch Poly	6*10	210~280	1650*992  1650*990	280	420	35*25 & 40*30 & 40*20 & 40*35 & 45*35 & 50*35  40*20 & 40*35
JKMXXXM-60 JKMXXXM-60-J JKMxxxM-60-(Plus) JKMXXXM-60B	6 inch Mono	6*10	210~280	1650*992	280	420	35*25 & 40*30 & 40*20 & 40*35 & 45*35 & 50*35
JKMXXXP-72 JKMXXXP-72-J JKMXXXPP-72 JKMXXXPP-72-J JKMSxxxP-72(Plus) JKMXXXP-72B	6 inch Poly	6*12	250~340	1956*992	280	480	40*30 & 40*20 & 40*35 & 50*35
JKMXXXM-72 JKMXXXM-72-J JKMxxxM-72(Plus) JKMXXXM-72B	6 inch Mono	6*12	250~335	1956*992	280	480	40*20 & 40*30 & 50*35 & 40*35
JKMxxxM-48 JKMxxxM-48-J	6 inch Mono	6*8	170~220	1324*992	240	270	40*35
JKMSxxxM-48-J JKMSxxxM-48(Plus)	6 inch Mono	6*8	170~220	1324*992	240	270	40*35
JKMxxxP-48 JKMxxxPP-48 JKMxxxPP-48-J JKMxxxPP-48(Plus)	6 inch Poly	6*8	170~225	1324*992	240	270	40*35
JKMSxxxP-48-J JKMSxxxP-48(Plus)	6 inch Poly	6*8	170~225	1324*992	240	270	40*35

**Max. Pressure:** 5400Pa mechanical load

**Table 2: Mechanical dimensions when modules installed at long side with Clamp fitting method**

2) Light PV module:

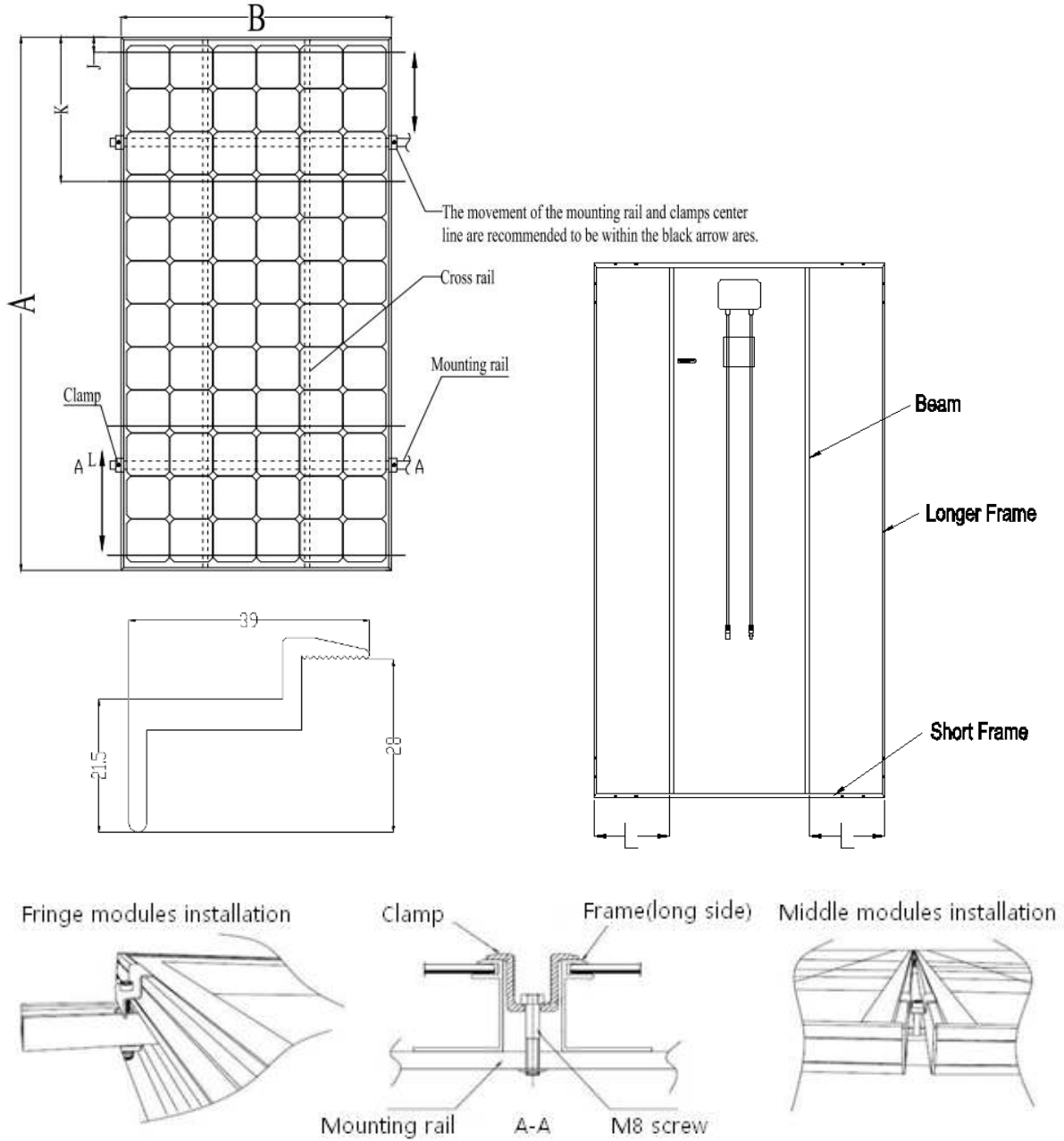

Figure 4: Light PV module installed at long side with Clamp fitting method

	Dimension (mm*mm)
<b>Longer Frame Section:</b>	28*6.9
<b>Short Frame Section:</b>	28*15
<b>Beam Section:</b>	19*15



Module type	Cell type	Cell quantity	Pmax (Wp)	Dimension(mm)			
				A*B	J	K	L
JKMXXXM-72 JKMXXXM-72-J JKMXXXM-72B	5 inch Mono	6*12	160~215	1580*808	280	320	270
JKMXXXM-96 JKMXXXM-96-J JKMXXXM-96B	5 inch Mono	8*12	210~285	1575*1082	280	320	270
JKMXXXP-60 JKMXXXP-60-J JKMXXXPP-60 JKMXXXPP-60-J JKMxxxP-60(Plus) JKMxxxPP-60(Plus) JKMXXXP-60B	6 inch Poly	6*10	210~280	1650*992	300	340	330
JKMXXXM-60 JKMXXXM-60-J JKMxxxM-60-(Plus) JKMXXXM-60B	6 inch Mono	6*10	210~280	1650*992	300	340	330
JKMXXXP-72 JKMXXXP-72-J JKMXXXPP-72 JKMXXXPP-72-J JKMxxxP-72(Plus) JKMXXXP-72B	6 inch Poly	6*12	250~340	1956*992	420	460	330
JKMXXXM-72 JKMXXXM-72-J JKMxxxM-72(Plus) JKMXXXM-72B	6 inch Mono	6*12	250~335	1956*992	420	460	330
JKMSXXXM-72 JKMSXXXM-72-J	5 inch Mono	6*12	160~215	1580*804 1580*808	280	320	270
JKMSXXXM-96 JKMSXXXM-96-J	5 inch Mono	8*12	210~280	1580*1060 1575*1082	280	320	270
JKMSXXXP-60 JKMSXXXP-60-J JKMSxxxP-60(Plus)	6 inch Poly	6*10	210~280	1636*990 1650*992	300	340	330
JKMSXXXM-60 JKMSXXXM-60-J JKMSxxxM-60(Plus)	6 inch Mono	6*10	210~280	1636*990 1650*992	300	340	330

JKMSXXXP-72 JKMSXXXP-72-J JKMSxxxP-72(Plus)	6 inch Poly	6*12	250~335	1952*990	420	460	330
				1956*992			
JKMSXXXM-72 JKMSXXXM-72-J JKMSxxxM-72(Plus)	6 inch Mono	6*12	250~335	1952*990	420	460	330
				1956*992			

**Max. Pressure:** 2400Pa mechanical load

**Table 3: Mechanical dimensions when modules installed at long side with Clamp fitting method**

### 2.3.3 Fixation with clamps at short sides of the frames

The applicable Products please refer to Table 4, only refer to the Normal PV module, and only allow using clamps at short side of frames.

The considerations and requirements about mounted by using clamps, please refer to the instructions in 2.3.2, and find detailed mounting information in the below illustration as Figure 5, the mounting place distance is suggested bigger than J and less than K, as shown below.

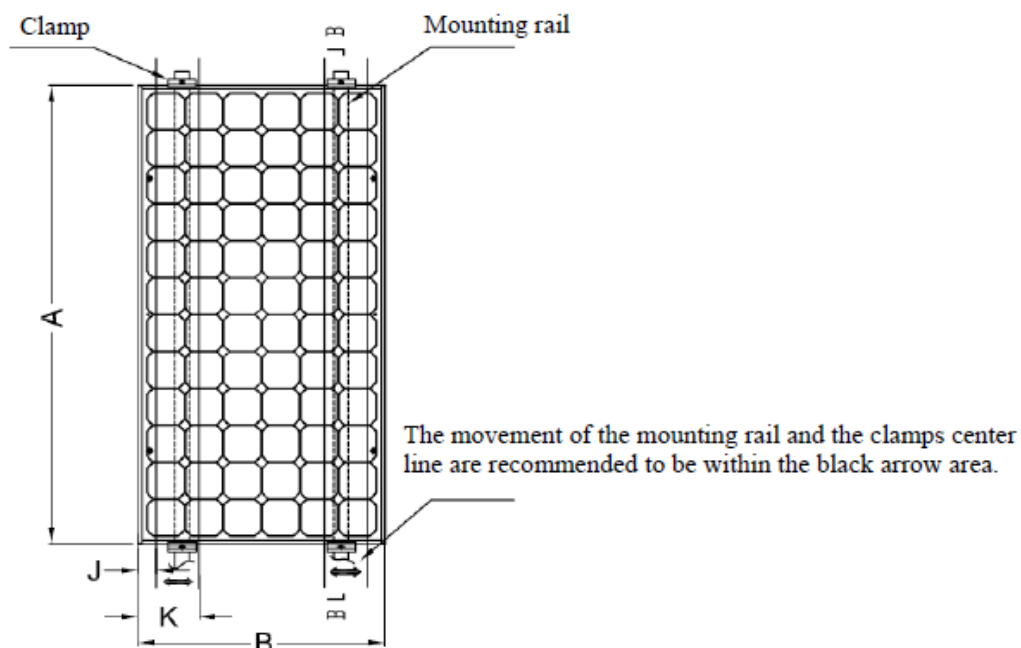

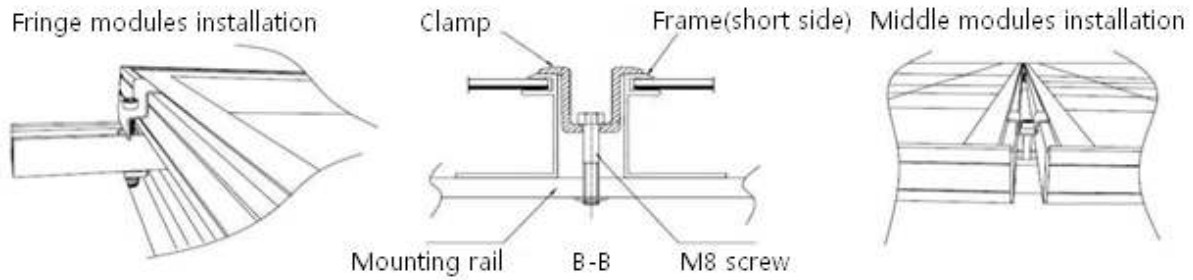

Figure 5: PV module installed at short side with Clamp fitting method

Module type	Cell type	Cell quantity	Pmax (Wp)	Dimension(mm)			
				A*B	J	K	Frame
JKMSXXXP-60 JKMSXXXP-60-J JKMSxxxP-60(Plus)	6 inch Poly	6*10	210~280	1650*992	50	240	40*35
JKMSXXXM-60 JKMSXXXM-60-J JKMSxxxM-60(Plus)	6 inch Mono	6*10	210~280	1650*992	50	240	40*35
JKMSXXXP-72 JKMSXXXP-72-J JKMSxxxP-72(Plus)	6 inch Poly	6*12	250~335	1956*992	50	240	40*35
JKMSXXXM-72 JKMSXXXM-72-J JKMSxxxM-72(Plus)	6 inch Mono	6*12	250~335	1956*992	50	240	40*35
JKMXXXM-72 JKMXXXM-72-J JKMXXXM-72B	5 inch Mono	6*12	160~215	1580*808	50	200	40*35
JKMXXXM-96 JKMXXXM-96-J JKMXXXM-96B	5 inch Mono	8*12	210~285	1575*1082	50	260	40*35
JKMXXXP-60 JKMXXXP-60-J JKMXXXPP-60 JKMXXXPP-60-J JKMxxxP-60(Plus) JKMxxxPP-60(Plus) JKMXXXP-60B	6 inch Poly	6*10	210~280	1650*992	50	240	40*35
				1650*990			40*35

JKMXXXM-60 JKMXXXM-60-J JKMxxxM-60-(Plus) JKMXXXM-60B	6 inch Mono	6*10	210~280	1650*992	50	240	40*35
JKMXXXP-72 JKMXXXP-72-J JKMXXXPP-72 JKMXXXPP-72-J JKMSxxxP-72(Plus) JKMXXXP-72B	6 inch Poly	6*12	250~340	1956*992	50	240	40*35
JKMXXXM-72 JKMXXXM-72-J JKMxxxM-72(Plus) JKMXXXM-72B	6 inch Mono	6*12	250~335	1956*992	50	240	40*35
JKMxxxM-48 JKMxxxM-48-J	6 inch Mono	6*8	170~220	1324*992	50	240	40*35
JKMSxxxM-48-J JKMSxxxM-48(Plus)	6 inch Mono	6*8	170~220	1324*992	50	240	40*35
JKMxxxP-48 JKMxxxPP-48 JKMxxxPP-48-J JKMxxxPP-48(Plus)	6 inch Poly	6*8	170~225	1324*992	50	240	40*35
JKMSxxxP-48-J JKMSxxxP-48(Plus)	6 inch Poly	6*8	170~225	1324*992	50	240	40*35

**Max. Pressure: 2400Pa mechanical load**

**Table 4: Mechanical dimensions when modules installed at short side with Clamp fitting method**

### 2.3.4 Fixation with clamps at the long & short sides

The applicable Products please refer to Table 5, only refer to the Normal PV module, and only allow installing modules at the long and short sides with clamps respectively. The considerations and requirements about mounted by using clamps, please refer to the instructions in 2.3.2, and find detailed mounting information in the below illustration as Figure 6, the mounting place distance is suggested bigger than J and less than K for short sides, bigger than M and less than N for long sides, as shown below.

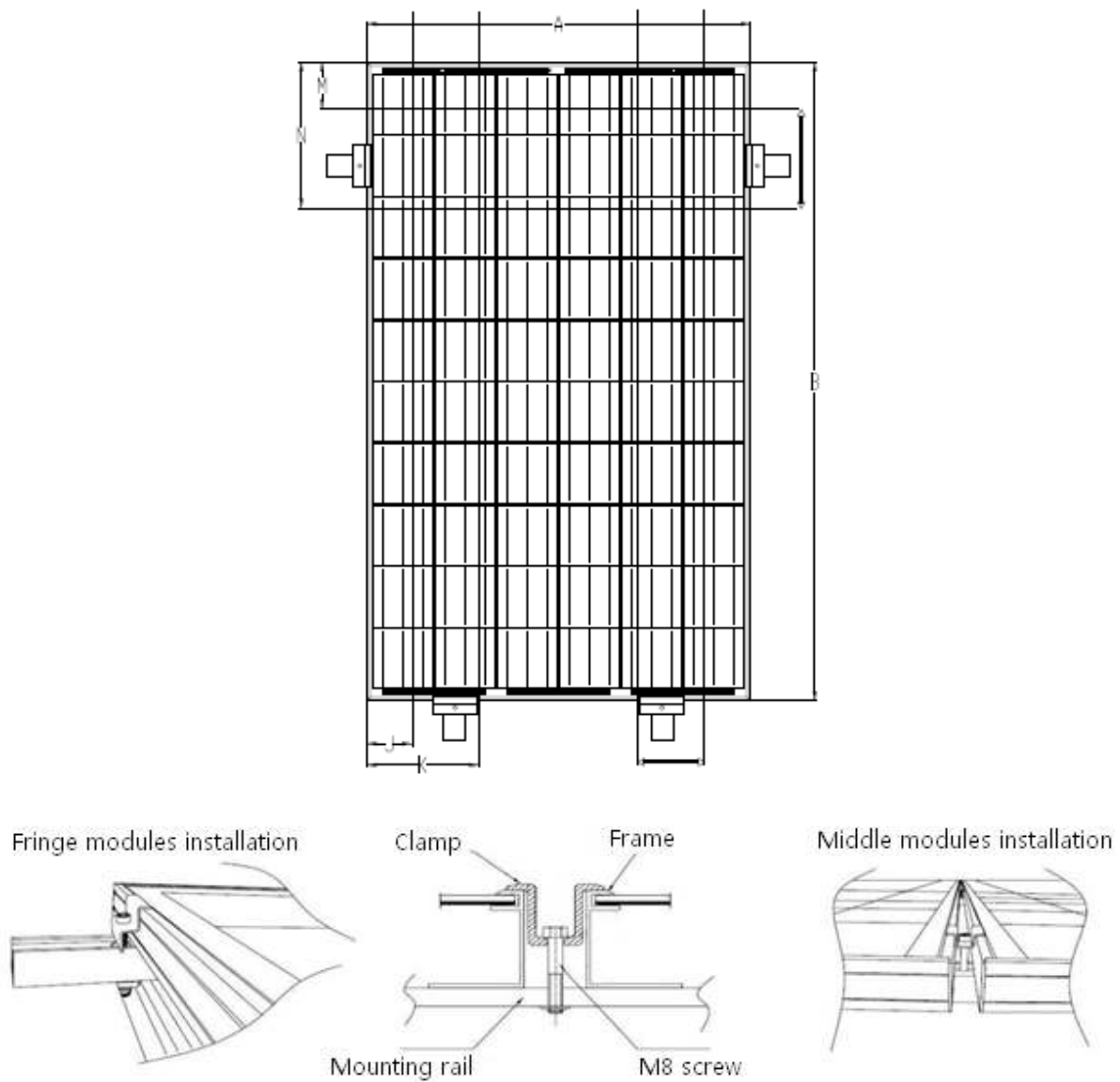

**Figure 6: PV module installed at long and short side with Clamp fitting method**

Module type	Cell type	Cell quantity	Pmax (Wp)	Dimension(mm)					
				A*B	J	K	M	N	Frame
JKMSXXXP-60 JKMSXXXP-60-J JKMSxxxP-60(Plus)	6 inch Poly	6*10	210~280	1650*992	50	240	280	420	40*35
JKMSXXXM-60 JKMSXXXM-60-J JKMSxxxM-60(Plus)	6 inch Mono	6*10	210~280	1650*992	50	240	280	420	40*35
JKMSXXXP-72 JKMSXXXP-72-J JKMSxxxP-72(Plus)	6 inch Poly	6*12	250~335	1956*992	50	240	280	480	40*35
JKMSXXXM-72 JKMSXXXM-72-J JKMSxxxM-72(Plus)	6 inch Mono	6*12	250~335	1956*992	50	240	280	480	40*35
JKMXXXM-72 JKMXXXM-72-J JKMXXXM-72B	5 inch Mono	6*12	160~215	1580*808	50	200	300	400	40*35
JKMXXXM-96 JKMXXXM-96-J JKMXXXM-96B	5 inch Mono	8*12	210~285	1575*1082	50	260	280	400	40*35
JKMXXXP-60 JKMXXXP-60-J JKMXXXPP-60 JKMXXXPP-60-J JKMxxxP-60(Plus) JKMxxxPP-60(Plus) JKMXXXP-60B	6 inch Poly	6*10	210~280	1650*992	50	240	280	420	40*35
				1650*990					40*35
JKMXXXM-60 JKMXXXM-60-J JKMxxxM-60-(Plus) JKMXXXM-60B	6 inch Mono	6*10	210~280	1650*992	50	240	280	420	40*35
JKMXXXP-72 JKMXXXP-72-J JKMXXXPP-72 JKMXXXPP-72-J JKMSxxxP-72(Plus) JKMXXXP-72B	6 inch Poly	6*12	250~340	1956*992	50	240	280	480	40*35

JKMXXXM-72 JKMXXXM-72-J JKMxxxM-72(Plus) JKMXXXM-72B	6 inch Mono	6*12	250~335	1956*992	50	240	280	480	40*35
JKMxxxM-48 JKMxxxM-48-J	6 inch Mono	6*8	170~220	1324*992	50	240	240	270	40*35
JKMSxxxM-48-J JKMSxxxM-48(Plus)	6 inch Mono	6*8	170~220	1324*992	50	240	240	270	40*35
JKMxxxP-48 JKMxxxPP-48 JKMxxxPP-48-J JKMxxxPP-48(Plus)	6 inch Poly	6*8	170~225	1324*992	50	240	240	270	40*35
JKMSxxxP-48-J JKMSxxxP-48(Plus)	6 inch Poly	6*8	170~225	1324*992	50	240	240	270	40*35

**Max. Pressure:** 2400Pa mechanical load

**Table 5: Mechanical dimensions when modules installed at long and short sides with Clamp fitting method**

### 2.3.5 Fixation with screws & clamps at the long & short sides

The applicable Products please refer to Table 6, only refer to the Normal PV module, and only allow installing modules at the long and short sides with screws and clamps respectively.

The considerations and requirements about mounted by using screws (clamps), please refer to the instructions in 2.3.1 (2.3.2), and find detailed mounting information in the below illustration as Figure 7, the mounting place distance on short side is suggested bigger than J and less than K, as shown below.

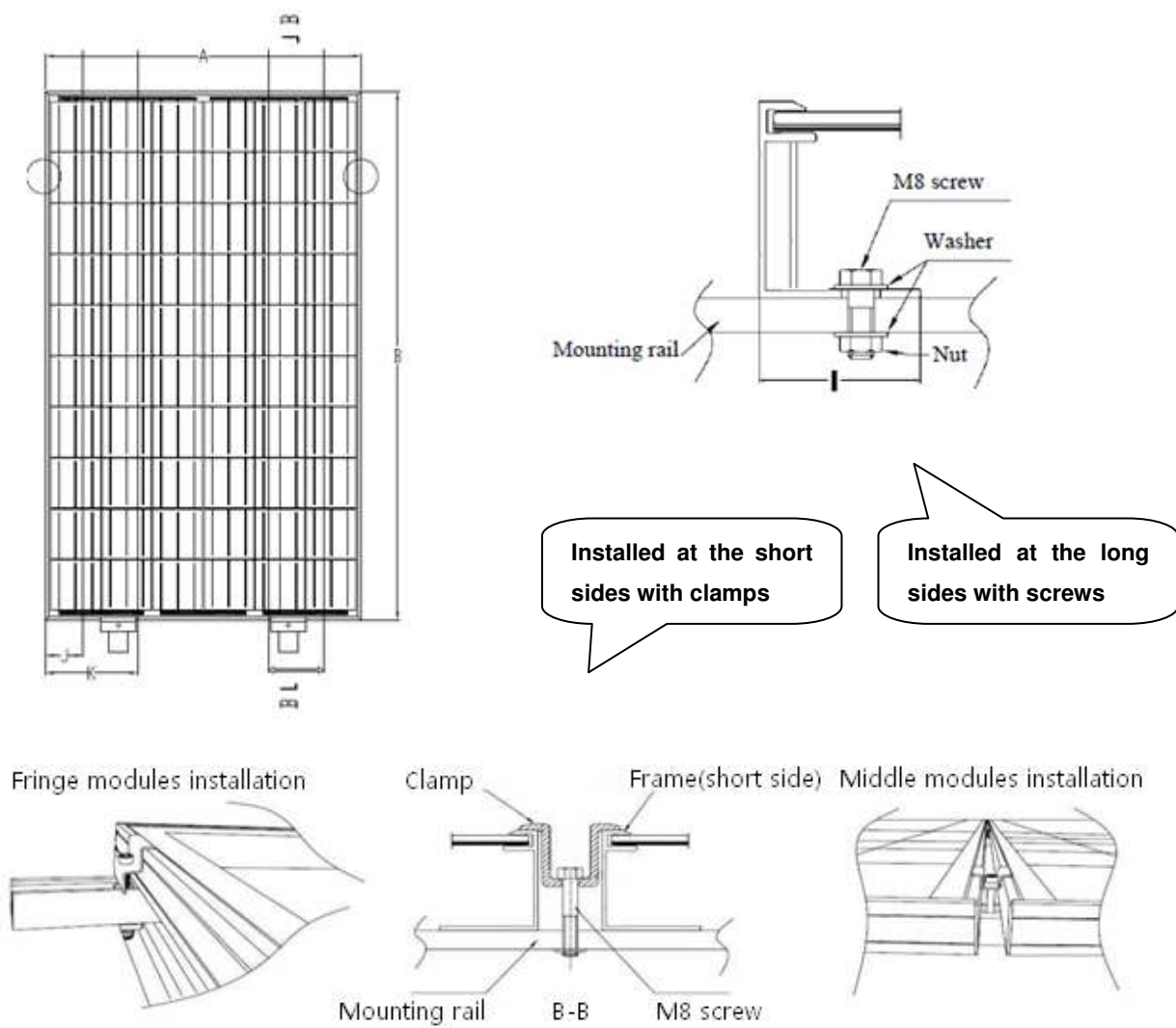

**Figure 7: PV module installed at long and short side with Screws and Clamps respectively**



Module type	Cell type	Cell quantity	Pmax (Wp)	Dimension(mm)			
				A*B	J	K	Frame
JKMSXXXP-60 JKMSXXXP-60-J JKMSxxxP-60(Plus)	6 inch Poly	6*10	210~280	1650*992	50	240	40*35
JKMSXXXM-60 JKMSXXXM-60-J JKMSxxxM-60(Plus)	6 inch Mono	6*10	210~280	1650*992	50	240	40*35
JKMSXXXP-72 JKMSXXXP-72-J JKMSxxxP-72(Plus)	6 inch Poly	6*12	250~335	1956*992	50	240	40*35
JKMSXXXM-72 JKMSXXXM-72-J JKMSxxxM-72(Plus)	6 inch Mono	6*12	250~335	1956*992	50	240	40*35
JKMXXXM-72 JKMXXXM-72-J JKMXXXM-72B	5 inch Mono	6*12	160~215	1580*808	50	200	40*35
JKMXXXM-96 JKMXXXM-96-J JKMXXXM-96B	5 inch Mono	8*12	210~285	1575*1082	50	260	40*35
JKMXXXP-60 JKMXXXP-60-J JKMXXXPP-60 JKMXXXPP-60-J JKMxxxP-60(Plus) JKMxxxPP-60(Plus) JKMXXXP-60B	6 inch Poly	6*10	210~280	1650*992	50	240	40*35
				1650*990			40*35
JKMXXXM-60 JKMXXXM-60-J JKMxxxM-60-(Plus) JKMXXXM-60B	6 inch Mono	6*10	210~280	1650*992	50	240	40*35

JKMXXXP-72 JKMXXXP-72-J JKMXXXPP-72 JKMXXXPP-72-J JKMSxxxP-72(Plus) JKMXXXP-72B	6 inch Poly	6*12	250~340	1956*992	50	240	40*35
JKMXXXM-72 JKMXXXM-72-J JKMxxxM-72(Plus) JKMXXXM-72B	6 inch Mono	6*12	250~335	1956*992	50	240	40*35
JKMxxxM-48 JKMxxxM-48-J	6 inch Mono	6*8	170~220	1324*992	50	240	40*35
JKMSxxxM-48-J JKMSxxxM-48(Plus)	6 inch Mono	6*8	170~220	1324*992	50	240	40*35
JKMxxxP-48 JKMxxxPP-48 JKMxxxPP-48-J JKMxxxPP-48(Plus)	6 inch Poly	6*8	170~225	1324*992	50	240	40*35
JKMSxxxP-48-J JKMSxxxP-48(Plus)	6 inch Poly	6*8	170~225	1324*992	50	240	40*35

**Max. Pressure:** 2400Pa mechanical load

**Table 6: Mechanical dimensions when modules installed at long and short sides with Screws and Clamps respectively**

### 3. Wiring and connection

- a) Before this procedure, please read the operation instructions of the PV system carefully. Make wiring by Multi-connecting cables between the PV modules in series or parallel connection, which is determined by user's configuration requirement for system power, current and voltage.
- b) PV module connected in series should have similar current, and modules must not be connected together to create a voltage higher than the permitted system voltage. The maximum number of modules in series depends on system design, the type of inverter used and environmental conditions.
- c) The maximum fuse rating value in an array string can be found on the product label or in the product datasheet. The fuse rating value is also corresponding to the

maximum reverse current that a module can withstand, i.e. when one string is in shade then the other parallel strings of modules will be load by the shade string and the current will pass through to create a current circuit. Thus based on the maximum series fuse rating of module and local electrical installation criteria, make sure the modules strings in parallel for connection need to be assembled with appropriate string fuse for circuit protection.

- d) Open the connection box of the control system and connect the cabled from the PV arrays to the connection box in accordance with the installation indication of the PV control systems. The cross-sectional area and cable connector capacity must satisfy the maximum short-circuit of PV system (For a single component, we recommended the cross-sectional area of cables is  $4\text{mm}^2$  and the rated current of connectors is more than 10A), otherwise cables and connectors will become overheating for large current. Please pay attention the temperature limit of cables is  $85^{\circ}\text{C}$ .
- e) All module frames and mounting racks must be properly grounded in accordance with local and national electrical codes. Attach the equipment grounding conductor to the module frame using the hole and hardware provided. Not that a stainless steel star washer is used between the ground wire and module frame (see Figure 8 below).This washer is used to avoid corrosion due to dissimilar metals. Tighten the screw securely.

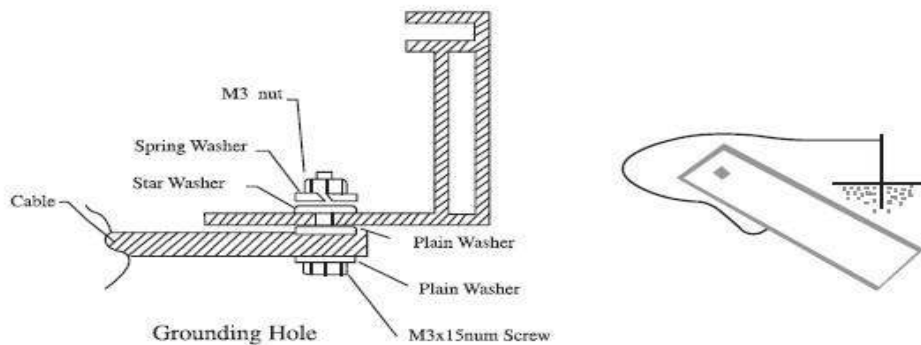
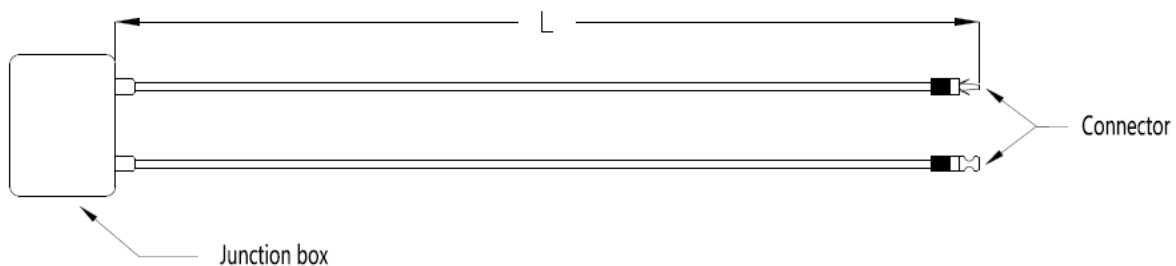

**Figure 8: The graph of Grounding**

- f) Follow the requirements of applicable local and national electrical codes.
- g) These modules contain factory installed bypass diode .if these modules are incorrectly connected to each other, the bypass diodes, cable or junction box may be damaged.
- h) The cable of the junction box is defined as L, as showed below in Figure 9. For Jinko standard module, L is 900/1200mm; and for customized module, L can be

based on your condition. Please take the cable length into consideration before designing the wiring layout.

- i) It is recommend to adopt inverter negatively earthed installation to avoid the PID effect for non-PID free modules.



**Figure 9: Junction box**

## 4. Maintenance and care

It is required to perform regular inspection and maintenance of the modules, especially within warranty scope. To ensure optimum module performance, Jinko recommends the following maintenance measures:

### 4.1 Visual Inspection

Inspect the Modules visually to find whether there are appearance defects, the following need to be paid more attention especially:

- a) Whether the glass is broken;
- b) No sharp objects are in contact with the PV module surfaces
- c) PV modules are not shaded by unwanted obstacles and/or foreign material
- d) Corrosion along the cells' bus-bar. The corrosion is caused by the dampness infiltrated into the Modules because that the surface encapsulation materials are damaged during the installation or transportation.
- f) Whether there is burning vestige on the backsheet.
- g) Check fixing screws and mounting brackets are tight, adjust and tighten as necessary.

## 4.2 Cleaning

- a) A built up of dust or dirt on the module(s) front face will result in a decreased energy output. Clean the panel(s) preferably once per annum if possible (depend on site conditions) using a soft cloth dry or damp, as necessary. Water with high mineral content may leave deposits on the glass surface and is not recommended.
- b) Never use abrasive material under any circumstances.
- c) In order to reduce the potential for electrical and thermal shock, Jinko recommends cleaning PV modules during early morning or late afternoon hours when solar radiation is low and the modules are cooler, especially in regions with hotter temperatures.
- d) Never attempt to clean a PV module with broken glass or other signs of exposed wiring, as this presents a shock hazard.

## 4.3 Inspection of Connector and Cable

It's recommended to implement the following preventive maintenance every 6 months:

- a) Check the sealing gels of the junction box to ensure it have no crack or crevice.
- b) Examine the PV module(s) for signs of deterioration. Check all wiring for possible rodent damage, weathering and that all connections are tight and corrosion free. Check electrical leakage to ground.

## 5. Electrical specification

The module electrical rating are measured under Standard Test Conditions, which are  $1000\text{W}/\text{m}^2$ , irradiance with AM 1.5 spectrum and 25 deg (77°F) ambient temperature. The module might produce more or less voltage or current than rating value in uncertainty condition.

The corresponding electrical specification can be downloaded from website [www.jinkosolar.com](http://www.jinkosolar.com).

## 6. Disclaimer of Liability

Because the use of the manual and the conditions or methods of installation, operation, use and maintenance of photovoltaic (PV) product are beyond Jinko's control, Jinko does not accept responsibility and expressly disclaims liability for loss ,damage, or expense arising out of or in any way connected with such installation, operation, use or maintenance.

No responsibility is assumed by Jinko for any infringement of patents or other rights of third parties, which may result from use of the PV product. NO license is granted by implication or otherwise under any patent or patent rights.

The information in this manual is based on Jinko's knowledge and experience and is believed to be reliable, but such information including product specification (without limitations) and suggestions do not constitute a warranty, expresses or implied. Jinko reserve the right to change the manual, the PV produce, the specifications, or product information sheets without prior notice.

### Note

---

---

---

---

---

---

---

---

#### **Global Sales & Marketing Center**

16F, Building No.2  
428# South Yang Gao Road,  
Shanghai, China 200127  
Tel: +86 21 6061 1799  
Fax: +86 21 6876 1115

#### **Jiangxi Manufacture Base**

No.1 Jinko Road,  
Shangrao Economic Development Zone,  
Jiangxi Province, China 334100  
Tel:+86 793 858 8188  
Fax:+86 793 846 1152

#### **Zhejiang Manufacture Base**

No.58 Yuanxi Road,  
Haining Yuanhua Industrial Park,  
Zhejiang Province, China 314416  
Tel: +86 573 8798 5678  
Fax: +86 573 8787 1070